

**mitsubishi**  
Mitsubishi Industrial Robot

# **CR750/CR751 Controller**

---

**INSTRUCTION MANUAL**  
**Troubleshooting**





This instruction manual apply to both the CR-750-Q/CR751-Q controller corresponding to iQ Platform, and the CR-750-D/CR751-D controller of standalone type.

**MELFA**  
**BFP-A8871-G**



## Safety Precautions

Always read the following precautions and the separate "Safety Manual" before starting use of the robot to learn the required measures to be taken.

-  **CAUTION** All teaching work must be carried out by an operator who has received special training. (This also applies to maintenance work with the power source turned ON.)  
Enforcement of safety training
-  **CAUTION** For teaching work, prepare a work plan related to the methods and procedures of operating the robot, and to the measures to be taken when an error occurs or when restarting. Carry out work following this plan. (This also applies to maintenance work with the power source turned ON.)  
Preparation of work plan
-  **WARNING** Prepare a device that allows operation to be stopped immediately during teaching work. (This also applies to maintenance work with the power source turned ON.)  
Setting of emergency stop switch
-  **CAUTION** During teaching work, place a sign indicating that teaching work is in progress on the start switch, etc. (This also applies to maintenance work with the power source turned ON.)  
Indication of teaching work in progress
-  **WARNING** Provide a fence or enclosure during operation to prevent contact of the operator and robot.  
Installation of safety fence
-  **CAUTION** Establish a set signaling method to the related operators for starting work, and follow this method.  
Signaling of operation start
-  **CAUTION** As a principle turn the power OFF during maintenance work. Place a sign indicating that maintenance work is in progress on the start switch, etc.  
Indication of maintenance work in progress
-  **CAUTION** Before starting work, inspect the robot, emergency stop switch and other related devices, etc., and confirm that there are no errors.  
Inspection before starting work

The points of the precautions given in the separate "Safety Manual" are given below. Refer to the actual "Safety Manual" for details.

- ⚠ CAUTION** Use the robot within the environment given in the specifications. Failure to do so could lead to a drop or reliability or faults. (Temperature, humidity, atmosphere, noise environment, etc.)
- ⚠ CAUTION** Transport the robot with the designated transportation posture. Transporting the robot in a non-designated posture could lead to personal injuries or faults from dropping.
- ⚠ CAUTION** Always use the robot installed on a secure table. Use in an instable posture could lead to positional deviation and vibration.
- ⚠ CAUTION** Wire the cable as far away from noise sources as possible. If placed near a noise source, positional deviation or malfunction could occur.
- ⚠ CAUTION** Do not apply excessive force on the connector or excessively bend the cable. Failure to observe this could lead to contact defects or wire breakage.
- ⚠ CAUTION** Make sure that the workpiece weight, including the hand, does not exceed the rated load or tolerable torque. Exceeding these values could lead to alarms or faults.
- ⚠ WARNING** Securely install the hand and tool, and securely grasp the workpiece. Failure to observe this could lead to personal injuries or damage if the object comes off or flies off during operation.
- ⚠ WARNING** Securely ground the robot and controller. Failure to observe this could lead to malfunctioning by noise or to electric shock accidents.
- ⚠ CAUTION** Indicate the operation state during robot operation. Failure to indicate the state could lead to operators approaching the robot or to incorrect operation.
- ⚠ WARNING** When carrying out teaching work in the robot's movement range, always secure the priority right for the robot control. Failure to observe this could lead to personal injuries or damage if the robot is started with external commands.
- ⚠ CAUTION** Keep the jog speed as low as possible, and always watch the robot. Failure to do so could lead to interference with the workpiece or peripheral devices.
- ⚠ CAUTION** After editing the program, always confirm the operation with step operation before starting automatic operation. Failure to do so could lead to interference with peripheral devices because of programming mistakes, etc.
- ⚠ CAUTION** Make sure that if the safety fence entrance door is opened during automatic operation, the door is locked or that the robot will automatically stop. Failure to do so could lead to personal injuries.
- ⚠ CAUTION** Never carry out modifications based on personal judgments, or use non-designated maintenance parts. Failure to observe this could lead to faults or failures.
- ⚠ WARNING** When the robot arm has to be moved by hand from an external area, do not place hands or fingers in the openings. Failure to observe this could lead to hands or fingers catching depending on the posture.

**⚠ CAUTION**

Do not stop the robot or apply emergency stop by turning the robot controller's main power OFF. If the robot controller main power is turned OFF during automatic operation, the robot accuracy could be adversely affected. Moreover, it may interfere with the peripheral device by drop or move by inertia of the arm.

**⚠ CAUTION**

Do not turn off the main power to the robot controller while rewriting the internal information of the robot controller such as the program or parameters. If the main power to the robot controller is turned off while in automatic operation or rewriting the program or parameters, the internal information of the robot controller may be damaged.

**⚠ CAUTION**

Use the network equipments (personal computer, USB hub, LAN hub, etc) confirmed by manufacturer. The thing unsuitable for the FA environment (related with conformity, temperature or noise) exists in the equipments connected to USB. When using network equipment, measures against the noise, such as measures against EMI and the addition of the ferrite core, may be necessary. Please fully confirm the operation by customer. Guarantee and maintenance of the equipment on the market (usual office automation equipment) cannot be performed.

\*CR751-D or CR751-Q controller  
Notes of the basic component are shown.

**⚠ CAUTION**

Please install the earth leakage breaker in the primary side supply power supply of the controller of CR751-D or CR751-Q because of leakage protection.

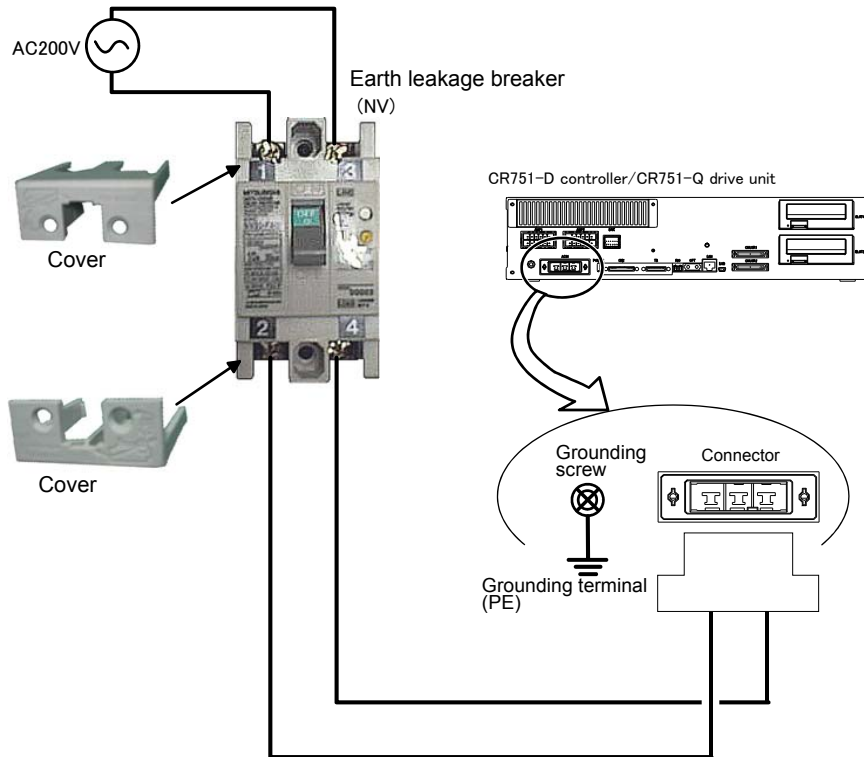

Revision history

Date of print	Specifications No.	Details of revisions
2012-02-13	BFP-A8871	<ul style="list-style-type: none"> <li>• First print</li> </ul>
2012-06-11	BFP-A8871-A	<ul style="list-style-type: none"> <li>• Error H096n was corrected (measures in RH-20FH).</li> <li>• The cause and measures of error H017m were corrected.</li> </ul>
2012-06-18	BFP-A8871-B	<ul style="list-style-type: none"> <li>• The measures of H096n was corrected (measures in RH-20FH)</li> </ul>
2012-09-03	BFP-A8871-C	<ul style="list-style-type: none"> <li>• The measures of H0094 was corrected.</li> <li>• Error L4939 and L2050 were added.</li> </ul>
2012-10-15	BFP-A8871-D	<ul style="list-style-type: none"> <li>• The message and cause of the error L3110 and L3120 were corrected.</li> </ul>
2012-11-20	BFP-A8871-E	<ul style="list-style-type: none"> <li>• Error C043n was added.</li> <li>• The statement about trademark registration was added.</li> <li>• The issue item of the “2.1 Appendix” was added.</li> </ul>
2013-07-17	BFP-A8871-F	<ul style="list-style-type: none"> <li>• Error C1940 was added.</li> <li>• The measures of H8800 was corrected.</li> <li>• The cause and measures of following errors were corrected. H0050, H0060, H0080, H0083, H0087, H0088, H0090, H0093, H0094, H0141, H104n, H107n, L182n, C1920</li> </ul>
2013-09-10	BFP-A8871-G	<ul style="list-style-type: none"> <li>• The measures of H096n and C133n were added.</li> <li>• The causes and measures of H112n was modified.</li> <li>• “The T/B does not display anything.” was added to “Appendix 3: Troubles and measures”</li> </ul>

## ■ Introduction

Thank you for purchasing the Mitsubishi industrial robot. This instruction manual describes the causes and measures for errors that may occur while using the robot.

If an error should occur, refer to this manual and take appropriate measures.

Apply to both the CR750-Q/CR751-Q series controller corresponding to iQ Platform, and the CR750-D/CR751-D series controller of standalone. Especially the function added individually is indicated to be "CR750-Q" and "CR750-D".

### Notice

- \*ONLY QUALIFIED SERVICE PERSONNEL MAY INSTALL OR SERVICE THE ROBOT SYSTEM.
- \*ANY PERSON WHO PROGRAM, TEACHES, OPERATE, MAINTENANCE OR REPAIRS THE ROBOT SYSTEM IS TRAINED AND DEMONSTRATES COMPETENCE TO SAFELY PERFORM THE ASSIGNED TASK.
- \*ENSURE COMPLIANCE WITH ALL LOCAL AND NATIONAL SAFETY AND ELECTRICAL CODES FOR THE INSTALLATION AND OPERATION OF THE ROBOT SYSTEM.

- No part of this manual may be reproduced by any means or in any form, without prior consent from Mitsubishi.
- The contents of this manual are subject to change without notice.
- An effort has been made to make full descriptions in this manual. However, if any discrepancies or unclear points are found, please contact your service provider.
- The information contained in this document has been written to be accurate as much as possible. Please interpret that items not described in this document "cannot be performed." or "alarm may occur".  
Please contact your service provider if you find any doubtful, wrong or skipped point.
- This specifications is original.
- The ETHERNET is a registered trademark of the Xerox Corp.
- All other company names and production names in this document are the trademarks or registered trademarks of their respective owners.

# Contents

	Page
1 Error list .....	1-1
(1) Error No. ....	1-1
(2) If the display of the operation panel goes out .....	1-1
(3) Cause and measures against the error .....	1-1
2Appendix .....	Appendix-43
Appendix 1: Place where fuse replacement is required .....	Appendix-43
Appendix 2: Fan installation place of robot controller (drive unit). ....	Appendix-45
Appendix 3: Troubles and measures .....	Appendix-46



## 1 Error list

### (1) Error No.

When an error occurs, a 5-digit error No. (example: "C0010") will appear at the STATUS NUMBER display on the operation panel at the front of the controller, and the [RESET] switch lamp will light.

The four-digit error number (number except the one character of the head,) is displayed on LCD of T/B.

Example: In the case of C0010, display the display and the error message for "0010."

The message, cause and measures to be taken are displayed in [Table 1-1](#) for the error Nos. that may appear.

Also, a detailed message will be displayed on the Error History screen of the T/B, depending on the error No. of the error occurred. Check by displaying the Error History screen after resetting the error.

If the error recurs even after the measures in the table are taken, contact your service provider.

[Note] • The meaning of the error Nos. in [Table 1-1](#) are shown below.

- 0000 \*
- An error marked with a \* reset by turning the power OFF and ON.  
Take the measures given.
  - The error type is indicated with a 4-digit number.
  - Three types of error classes are indicated.  
H: High level error .....The servo turns OFF.  
L: Low level error .....The operation will stop.  
C: Warning .....The operation will continue.

- The axis No. may be indicated at the last digit of the error No.

Example) H0931 No. 1 axis motor overcurrent.

### (2) If the display of the operation panel goes out

If the operation panel display of the front of the controller (drive unit) goes out, turn off the power supply once, and turn on again.

If the error occurs, please take measures with reference to "[Table 1-1: Error list](#)" And, please confirm the error history, even if no error occurred, and take necessary measures. Refer to the separate manual, "Instruction Manual/Detailed Explanation of Functions and Operations" for the confirmation method of the error history. If the operation panel display goes out again after measures, please contact to your service provider.

### (3) Cause and measures against the error

The details, cause and measures of the error number occurrence are shown in [Table 1-1](#).

Note) The contents of the error caused with option products are written in the instruction manual of the option. Refer to each instruction manual.

Table 1-1 : Error list

Error No.	Error cause and measures	
H0001	Error message	Fail safe error (SRVOFF)
	Cause	The system may be abnormal.
	Measures	Turn the power OFF and ON once. If it comes back, contact to your service provider.
H0002	Error message	Fail safe error (STOP)
	Cause	The system may be abnormal.
	Measures	Turn the power OFF and ON once. If it comes back, contact to your service provider.
H0003	Error message	The system is abnormal.
	Cause	The problem of the system is the cause.
	Measures	If it comes back, contact to your service provider.
H0004 *	Error message	CPU Watch dog error
	Cause	CPU was not normally treatable
	Measures	It is necessary to change some parts when not improvement. If it comes back, contact to your service provider.

Error No.	Error cause and measures	
H0009 *	Error message	Version UP (ALL)
	Cause	Message at version up.
	Measures	Turn the power OFF and ON once.
	Error message	Version UP (MAIN)
	Cause	Version UP (MAIN)
	Measures	Turn the power OFF,ROTSW=0 and power ON once
	Error message	Version UP (SERVO)
	Cause	Version UP (SERVO)
	Measures	Turn the power OFF,ROTSW=0 and power ON once
	Error message	The servo s/w was written
	Cause	The servo s/w was written
Measures	Turn the power OFF and power ON once	
C0010	Error message	Illegal Version (file)
	Cause	The version is inconsistent.
	Measures	The file has been automatically initialized. The program is being deleted.
C0011	Error message	Illegal Version (system data)
	Cause	The version is inconsistent.
	Measures	The file has been automatically initialized. Turn the power OFF and ON once.
C0012	Error message	Initialize (error log)
	Cause	The error log has been initialized because of version mismatch or the error log file is abnormal.
	Measures	Reset the alarm, and continue the operation.
C0013 *	Error message	Illegal file
	Cause	Data including programs may have been damaged.
	Measures	Contact your service provider as the initialization operation is required.
H0014 *	Error message	System error (illegal MECHA)
	Cause	A character string cannot exceed 14 characters.
	Measures	Re-input the correct name.
H0015 *	Error message	Illegal Version (file)
	Cause	Illegal Version (file)
	Measures	Contact the maker.
L0016 *	Error message	Turn the power OFF and ON once
	Cause	The time from turning the power OFF to turning the power ON again is too short.
	Measures	Give more time before turning the power ON again after turning the power OFF.
H0020 *	Error message	System Error (same name is Backup data.)
	Cause	The data of the system backup area is abnormal.
	Measures	Please consult your service provider.
H0021 *	Error message	System Error (Backup data is Count over.)
	Cause	The control region is overflowing.
	Measures	Please consult your service provider.
H0022 *	Error message	System Error (Backup data is no area.)
	Cause	The region is too small.
	Measures	Please consult your service provider.
L0030	Error message	Hand error. LS release
	Cause	This is a user setting error.
	Measures	Reset the error after removing the cause.
L0031	Error message	Air pressure error
	Cause	This is a user setting error.
	Measures	Reset the error after releasing the cause.

Error No.	Error cause and measures	
H0039	Error message	Door Switch Signal line is faulty.
	Cause	The one point of contact in 2 points of contact of the door switch has broken. Or wiring is not the double lines.
	Measures	Turn off the power supply. Confirm whether there is any problem in wiring of the switch. And, please confirm whether it is wiring of the double line. Refer to the "Examples of safety measures" given in separate "Standard Specifications Manual" for door switch wiring. Turn on the power supply again after checking.
H0040	Error message	Door Switch Signal is Input
	Cause	The door switch is open.
	Measures	Confirm whether the door switch input signal is connected correctly. And close the door connected to the input signal of door switch.
H0041 *	Error message	Comm. error (Remote I/O #1).
	Cause	Communication line is illegal.
	Measures	Checks the remote I/O cable connection between the CPU and the drive unit in the CR750-Q/CR751-Q controller. Checks the communication cable is grounded correctly or connected correctly.
	Error message	The CRC error of remote I/O channel 1 occurs
	Cause	An error was found in the communication line for remote I/O channel 1.
	Measures	Checks the remote I/O cable connection between the CPU and the drive unit in the CR750-Q/CR751-Q controller.
H0042 *	Error message	Comm. error (Remote I/O #2).
	Cause	Communication line is illegal.
	Measures	Checks the remote I/O cable connection in the CR750-Q/CR751-Q controller.
H0044	Error message	OP Mode key line is faulty.
	Cause	The state of doubled line is not matching (OP Mode key line)
	Measures	Turn the power OFF and ON once. If it comes back, contact to your service provider.
H0045	Error message	Faulty Line (T/B Enable Switch).
	Cause	The state of doubled line is not matching (T/B Enable Switch).
	Measures	Turn the power OFF and ON once. If it comes back, contact to your service provider.
H0046	Error message	Faulty wiring (Enabling Device).
	Cause	The state of doubled wiring is not matching (Enabling Device).
	Measures	Turn off the power and confirm whether wiring of the switch is right. Wiring needs to be doubled. Refer to the separate manual, "Standard Specifications Manual" for wiring of the door switch.
H0050	Error message	EMG signal is input. (external)
	Cause	1) The external emergency stop is being input. If the emergency stop of T/B turns on, this error may occur simultaneously. 2) The fuse (4A fuse) installed at the bottom of the 24 V power supply circuit in the controller may have blown out. For the fuse blowout, the emergency stop made by the customer may be the cause, or there may be a ground fault or short circuit with the 24 V power supply in the wiring of a door switch, enabling device, etc.
	Measures	1) Release the external emergency stop signal. 2) Investigate and correct the ground fault or short circuit portion in the wiring made by the customer. Then, replace the fuse inside the controller. Refer to <a href="#">Page 44</a> , "Fig-2-2 : Fuse (F8) exchange place" for details. (On details of the fuse, contact the manufacturer.)
H0051	Error message	Wiring of the external emergency stop is abnormal.
	Cause	If the emergency stop of T/B turns on, this error may occur simultaneously.
	Measures	Turn OFF the power supply. Confirm whether there is any problem in wiring of the external emergency stop switch. And, please confirm whether it is wiring of the dual line. Refer to the "Examples of safety measures" given in separate "Standard Specifications Manual" for external emergency stop switch wiring. Turn on the power supply again after checking.

Error No.	Error cause and measures	
H0053	Error message	EMG signal is input.(Add.Axis2)
	Cause	The external emergency stop to addition axis amplifier is inputting.
	Measures	Check the emergency stop of Additional Axis servo amp. Or the EM1 (forced outage) line of the addition axis may be open. Please confirm connection. In addition, the External Emergency Stop 1 and 2 are separated. The "External Emergency Stop 1" is for I/F card, and the "External Emergency Stop 2" is for main device of the amplifier
H0060	Error message	EMG signal is input. (O.Panel)
	Cause	1) The operation panel emergency stop is being input. 2) The fuse (4A fuse) installed at the bottom of the 24 V power supply circuit in the controller may have blown out. For the fuse blowout, the emergency stop made by the customer may be the cause, or there may be a ground fault or short circuit with the 24 V power supply in the wiring of a door switch, enabling device, etc.
	Measures	1) Cancel the operation panel emergency stop. 2) Investigate and correct the ground fault or short circuit portion in the wiring made by the customer. Then, replace the fuse inside the controller. Refer to <a href="#">Page 44</a> , "Fig.2-2 : Fuse (F8) exchange place" for details. (On details of the fuse, contact the manufacturer.)
H0061	Error message	EMG line is faulty.(O.Panel)
	Cause	The emergency stop line isn't stable.
	Measures	Confirm whether there is any problem in wiring of the external emergency stop switch. And, please confirm whether it is wiring of the double line. Refer to the "Examples of safety measures" given in separate "Standard Specifications Manual" for external emergency stop switch wiring. Turn on the power supply again after checking.
H0070	Error message	EMG signal is input. (T.Box)
	Cause	EMG signal is input. (T.Box) Or when using the UL specification, the brake release switch is turning ON.
	Measures	Cancel the T/B emergency stop. Check the emergency stop switch of teaching pendant.. Or when using the UL specification, turn OFF the brake release switch. If the alarm cannot be canceled, check the fuse of the safe unit (TZ348). If the fuse broke off, exchange new fuse.
H0071	Error message	EMG line is faulty.(T.Box)
	Cause	The emergency stop line isn't stable.
	Measures	Confirm whether there is any problem in wiring of the external emergency stop switch. And, please confirm whether it is wiring of the double line. Refer to the "Examples of safety measures" given in separate "Standard Specifications Manual" for external emergency stop switch wiring. Turn on the power supply again after checking.
H0074	Error message	Faulty line (T/B Enable/Disable).
	Cause	The state of doubled line is not matching (T/B Enable/Disable).
	Measures	Confirm whether T/B is connected correctly. If it comes back, contact to your service provider.
H0075	Error message	TB communication error
	Cause	Communication between the RC and TB was cut off.
	Measures	If it comes back, contact your service provider.
H0083 *	Error message	Fuse is broken (hand input power)
	Cause	1) The pneumatic hand's power fuse has broken. Possibly the power supply line of the hand input signal short-circuited. 2) The fuse (4A fuse) installed at the bottom of the 24 V power supply circuit in the controller may have blown out. For the fuse blowout, the emergency stop made by the customer may be the cause, or there may be a ground fault or short circuit with the 24 V power supply in the wiring of a door switch, enabling device, etc.
	Measures	1) Confirm that the hand input cable is connected correctly. Exchange the fuse. Refer to the <a href="#">Page 43</a> , "Fig.2-1 : Fuse (F3) exchange place" for details. 2) Investigate and correct the ground fault or short circuit portion in the wiring made by the customer. Then, replace the fuse inside the controller. Refer to <a href="#">Page 44</a> , "Fig.2-2 : Fuse (F8) exchange place" for details. (On details of the fuse, contact the manufacturer.)
H0084 *	Error message	Fuse is broken (O/P)
	Cause	The operation panel's power fuse has broken.
	Measures	Exchange the fuse.

Error No.	Error cause and measures	
H0086	Error message	Hand module overcurrent
	Cause	The motorized hand's motor or circuit board has broken.
	Measures	Exchange the motorized hand's motor or circuit board.
H0087	Error message	Fuse is blown.(Brake)
	Cause	1) Fuse is blown.(Brake) 2) The fuse (4A fuse) installed at the bottom of the 24 V power supply circuit in the controller may have blown out. For the fuse blowout, the emergency stop made by the customer may be the cause, or there may be a ground fault or short circuit with the 24 V power supply in the wiring of a door switch, enabling device, etc.
	Measures	1) Change fuse. 2) Investigate and correct the ground fault or short circuit portion in the wiring made by the customer. Then, replace the fuse inside the controller. Refer to <a href="#">Page 44, "Fig.2-2 : Fuse (F8) exchange place"</a> for details. (On details of the fuse, contact the manufacturer.)
H0088	Error message	Service I/F fuse error
	Cause	1) In SQ series, when the power supply of robot CPU is turned on, the drive unit has not started. 2) The fuse (4A fuse) installed at the bottom of the 24 V power supply circuit in the controller may have blown out. For the fuse blowout, the emergency stop made by the customer may be the cause, or there may be a ground fault or short circuit with the 24 V power supply in the wiring of a door switch, enabling device, etc.
	Measures	1) The order which turns on the power supply should turn on the power supply of robot CPU, in the condition that the drive unit is started previously. 2) Investigate and correct the ground fault or short circuit portion in the wiring made by the customer. Then, replace the fuse inside the controller. Refer to <a href="#">Page 44, "Fig.2-2 : Fuse (F8) exchange place"</a> for details. (On details of the fuse, contact the manufacturer.)
H0090	Error message	DC24V fuse is blown.
	Cause	1) DC24V fuse is blown. 2) The fuse (4A fuse) installed at the bottom of the 24 V power supply circuit in the controller may have blown out. For the fuse blowout, the emergency stop made by the customer may be the cause, or there may be a ground fault or short circuit with the 24 V power supply in the wiring of a door switch, enabling device, etc.
	Measures	1) Change fuse. 2) Investigate and correct the ground fault or short circuit portion in the wiring made by the customer. Then, replace the fuse inside the controller. Refer to <a href="#">Page 44, "Fig.2-2 : Fuse (F8) exchange place"</a> for details. (On details of the fuse, contact the manufacturer.)
L0091	Error message	Can't access the Special signal
	Cause	The dedicated output signal is assigned to the specified signal. This signal cannot be used in duplicate.
	Measures	Confirm whether the same dedicated output number is assigned to the separate dedicated output signal. Change the output No., or change the dedicated output assignment parameter.
H0093	Error message	1) Safety relay fuse is blown. 2) The fuse (4A fuse) installed at the bottom of the 24 V power supply circuit in the controller may have blown out. For the fuse blowout, the emergency stop made by the customer may be the cause, or there may be a ground fault or short circuit with the 24 V power supply in the wiring of a door switch, enabling device, etc.
	Cause	1) Safety relay fuse is blown. 2) Investigate and correct the ground fault or short circuit portion in the wiring made by the customer. Then, replace the fuse inside the controller. Refer to <a href="#">Page 44, "Fig.2-2 : Fuse (F8) exchange place"</a> for details. (On details of the fuse, contact the manufacturer.)
	Measures	Change fuse.
H0094	Error message	The overcurrent in the T/B line.
	Cause	1) The overcurrent in the T/B power supply line was detected. 2) The fuse (4A fuse) installed at the bottom of the 24 V power supply circuit in the controller may have blown out. For the fuse blowout, the emergency stop made by the customer may be the cause, or there may be a ground fault or short circuit with the 24 V power supply in the wiring of a door switch, enabling device, etc.
	Measures	1) Contact to the dealer. 2) Investigate and correct the ground fault or short circuit portion in the wiring made by the customer. Then, replace the fuse inside the controller. Refer to <a href="#">Page 44, "Fig.2-2 : Fuse (F8) exchange place"</a> for details. (On details of the fuse, contact the manufacturer.)

Error No.	Error cause and measures	
H0095	Error message	Brake release switch is turning on.
	Cause	Cannot execute while brake release switch is turning on.
	Measures	Please check the brake release switch and turn it off.
H0099	Error message	Servo version is illegal ** Note) The correct version of servo software is shown in "**".
	Cause	Servo software with an old version is installed.
	Measures	Change to the correct version of servo software is necessary. Contact your service provider.
H0100 *	Error message	Temperature in the Controller is too high
	Cause	The intake fan is not operating, or the fan filter is clogged.
	Measures	Check the operation of the intake fan, or clean or replace the fan filter if necessary. Confirms that the environmental temperature is the specification range. When it comes back, contact to the dealer.
L0101	Error message	Temperature in the Controller is too high
	Cause	The intake fan is not operating, or the fan filter is clogged.
	Measures	Check the operation of the intake fan, or clean or replace the fan filter if necessary. Confirms that the environmental temperature is the specification range. When it comes back, contact to the dealer.
C0102	Error message	Temperature in the Controller is too high
	Cause	The intake fan is not operating, or the fan filter is clogged.
	Measures	Check the operation of the intake fan, or clean or replace the fan filter if necessary. Confirms that the environmental temperature is the specification range. When it comes back, contact to the dealer.
H0120 *	Error message	Instantaneous power failure
	Cause	The power was OFF for 20msec or more
	Measures	Check the power supply connection and power supply state
H0130 *	Error message	The initialization connection error of system remote I/O.
	Cause	Communication line of System Remote I/O is illegal
	Measures	Confirm whether the communication cable is grounded correctly or connection correctly.
H0131 *	Error message	Plural Ope-panel are installed.
	Cause	One operation panel can be installed.
	Measures	Install only one operation panel.
H0140	Error message	Fuse is blown.(Safety unit)
	Cause	Fuse is blown.(Safety unit) If external emergency stop is turning ON, this error occurs.
	Measures	Cancel the external emergency stop. When it comes back, contact to the dealer.
H0141	Error message	Wiring error of EMGIN connector.
	Cause	1) Wiring error of CNUSR connector. 2) The fuse (4A fuse) installed at the bottom of the 24 V power supply circuit in the controller may have blown out. For the fuse blowout, the emergency stop made by the customer may be the cause, or there may be a ground fault or short circuit with the 24 V power supply in the wiring of a door switch, enabling device, etc.
	Measures	1) Please confirm the wiring for CNUSR. · When using the internal power supply, the following terminals has not connected. CR750 controller: between 1-2, 5-6 of CNUSR11/12. CR751 controller: between 1-26, 6-31, 3-28, 8-33 of CNUSR1. · When using the external power supply, the external power supply is not supplied. · The electrical wire connected to the following terminal is earth fault. CR750 controller: terminal 1 of CNUSR11/12. CR751 controller: terminal 1, 6 of CNUSR1. · The 24V power supply is supplied to the following terminal. CR750 controller: between 2-3 of CNUSR11/12. CR751 controller: between 26-2 or 31-7 of CNUSR1. When it comes back, contact to the dealer. 2) Investigate and correct the ground fault or short circuit portion in the wiring made by the customer. Then, replace the fuse inside the controller. Refer to Page 44, "Fig.2-2 : Fuse (F8) exchange place" for details. (On details of the fuse, contact the manufacturer.)

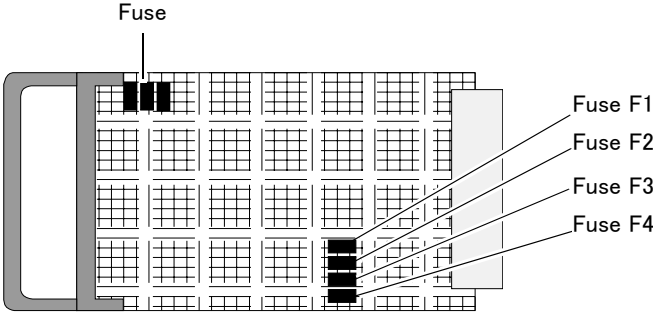
Error No.	Error cause and measures	
C0150	Error message	Undefined robot serial number
	Cause	Undefined robot serial number
	Measures	Input the robot serial number Refer to separate manual: "Controller setup, basic operation, and maintenance" for the setting method.
H016m (m=1 ~ 3)	Error message	Cannot use PIO I/F and Unit
	Cause	The I/O Channel number of PIO interface and PIO unit overlaps.
	Measures	Select either of Paralle I/O interface or Paralle I/O unit.
H017m (m=1 ~ 2)	Error message	Parallel I/O interface H/W error.
	Cause	The parallel-input/output card broke or the external power source for the parallel input/outputs was cut off.
	Measures	If it comes back, exchange the Parallel I/O interface card.
H018m (m=1 ~ 2)	Error message	Fuse is blown.(PIO) (Slot m-Fn)
	Cause	Fuse is blown.(Paralle I/O interface)
	Measures	Change fuse (Paralle I/O interface)
	Details	The electric fuse Fn (n= 1-4) of the parallel input output interface installed to the option slot m (m= 1-2) is open. Removes the cause by which the fuse open and replaces the fuse.
		
C043n (n indicates the axis number (1 to 8).)	Error message	Servo amplifier motor overheat
	Cause	The motor or detector's thermal protector activated.
	Measures	Reduce the speed and acceleration of the robot.
C049n * (n indicates the fan number (1 to 8).)	Error message	Alarm of fan in the robot
	Cause	Fan in the robot might be out of order
	Measures	Please exchange the fan in the robot
H050n * (n indicates the axis number (1 to 8).)	Error message	Servo axis setting error
	Cause	The setting of the axis number selection switch is illegal
	Measures	Confirm the setting of the axis selection switch
H0510 *	Error message	The converter setting is illegal
	Cause	The external emergency-stop input power was detected except external emergency-stop mode.
	Measures	Setting is wrong. When it comes back, contact to the dealer.
H0520 *	Error message	Robot axis setting illegal
	Cause	The setting of the servo axis used by the mechanism is duplicated with another mechanism's axis.
	Measures	Correctly set.
H053n * (n indicates the axis number (1 to 8).)	Error message	Servo sys. error (memory)
	Cause	The servo amplifier memory IC's check sum is illegal.
	Measures	Turn the power OFF and ON once. If it comes back, contact your service provider.
H054n * (n indicates the axis number (1 to 8).)	Error message	Servo sys. error (over run)
	Cause	The servo amplifier software data process did not end within the specified time.
	Measures	Turn the power OFF and ON once. If it comes back, contact your service provider.

Error No.	Error cause and measures	
H055n * (n indicates the axis number (1 to 8).)	Error message	Servo sys. error (mag. pole pos)
	Cause	An error was detected in the magnetic pole position detection signal of the detector.
	Measures	Turn the power OFF and ON once. If it comes back, contact your service provider.
H056n * (n indicates the axis number (1 to 8).)	Error message	Servo sys. error (A/D)
	Cause	An error was found in the servo amplifier's A/D converter during initialization.
	Measures	Turn the power OFF and ON once. If it comes back, contact your service provider.
H057n * (n indicates the axis number (1 to 8).)	Error message	Encoder error (EEPROM)
	Cause	An error was detected in EEPROM data of the serial pulse encoder.
	Measures	Turn the power OFF and ON once. Also, carefully check whether there is no deviation in the operating position of the robot. If it is deviated, set the origin position (OP) again. For more information about the operating procedure, refer to the separate volume, "Instruction Manual/Robot Arm Setup to Maintenance." If it comes back, contact your service provider.
H058n * (n indicates the axis number (1 to 8).)	Error message	Encoder error (LED)
	Cause	The LED of the serial pulse encoder has been deteriorated.
	Measures	Turn the power OFF and ON once. If it comes back, contact your service provider.
H059n * (n indicates the axis number (1 to 8).)	Error message	Encoder error (position data)
	Cause	An error was detected in the position data within a single rotation of the encoder.
	Measures	Turn the power OFF and ON once. Also, carefully check whether there is no deviation in the operating position of the robot. If it is deviated, set the origin position (OP) again. For more information about the operating procedure, refer to the separate volume, "Instruction Manual/Robot Arm Setup to Maintenance." If it comes back, contact your service provider.
H060n * (n indicates the axis number (1 to 8).)	Error message	Encoder no-signal detection 1
	Cause	An error was detected in the operating input of the detector mounted on the edge of the motor.
	Measures	Turn the power OFF and ON once. Also, carefully check whether there is no deviation in the operating position of the robot. If it is deviated, set the origin position (OP) again. For more information about the operating procedure, refer to the separate volume, "Instruction Manual/Robot Arm Setup to Maintenance." If it comes back, contact your service provider.
H061n * (n indicates the axis number (1 to 8).)	Error message	Encoder no-signal detection 2
	Cause	An error was detected in the operating input of the detector mounted on the edge of the machine.
	Measures	Turn the power OFF and ON once. Also, carefully check whether there is no deviation in the operating position of the robot. If it is deviated, set the origin position (OP) again. For more information about the operating procedure, refer to the separate volume, "Instruction Manual/Robot Arm Setup to Maintenance." If it comes back, contact your service provider.
H062n * (n indicates the axis number (1 to 8).)	Error message	Servo amplifier LSI error
	Cause	An operation error was detected in the LSI of the servo amplifier.
	Measures	Turn the power OFF and ON once. If it comes back, contact your service provider.
H063n * (n indicates the axis number (1 to 8).)	Error message	Unused axis servo error
	Cause	A power module error occurred in an axis which not use the movement control.
	Measures	Turn the power OFF and ON once. If it comes back, contact your service provider.
H064n * (n indicates the axis number (1 to 8).)	Error message	System error (ABS CPU)
	Cause	An error in the CPU of the absolute position linear scale was detected.
	Measures	Turn the power OFF and ON once. Also, carefully check whether there is no deviation in the operating position of the robot. If it is deviated, set the origin position (OP) again. For more information about the operating procedure, refer to the separate volume, "Instruction Manual/Robot Arm Setup to Maintenance." If it comes back, contact your service provider.
H065n * (n indicates the axis number (1 to 8).)	Error message	Absolute position error
	Cause	An error was detected in the absolute position detection circuit within the absolute position linear scale.
	Measures	Turn the power OFF and ON once. Also, carefully check whether there is no deviation in the operating position of the robot. If it is deviated, set the origin position (OP) again. For more information about the operating procedure, refer to the separate volume, "Instruction Manual/Robot Arm Setup to Maintenance." If it comes back, contact your service provider.



Error No.	Error cause and measures	
H066n * (n indicates the axis number (1 to 8).)	Error message	Incremental position error
	Cause	An error was detected in the relative position detection circuit within the absolute position linear scale.
	Measures	Turn the power OFF and ON once. Also, carefully check whether there is no deviation in the operating position of the robot. If it is deviated, set the origin position (OP) again. For more information about the operating procedure, refer to the separate volume, "Instruction Manual/Robot Arm Setup to Maintenance." If it comes back, contact your service provider.
H067n * (n indicates the axis number (1 to 8).)	Error message	Encoder CPU error
	Cause	An error was detected in the CPU of the position detector.
	Measures	Turn the power OFF and ON once. Also, carefully check whether there is no deviation in the operating position of the robot. If it is deviated, set the origin position (OP) again. For more information about the operating procedure, refer to the separate volume, "Instruction Manual/Robot Arm Setup to Maintenance." If it comes back, contact your service provider.
H068n * (n indicates the axis number (1 to 8).)	Error message	Encoder LED error
	Cause	Deterioration of the position detector's LED was detected.
	Measures	Turn the power OFF and ON once. If it comes back, contact your service provider.
H0700 *	Error message	P.S. external contactor fusing
	Cause	The contactor was turned ON even though READY is OFF.
	Measures	Turn the power OFF and ON once. If it comes back, contact your service provider.
H0710 *	Error message	Servo amp. relay error.
	Cause	The relay on servo cpu card did not turn ON.
	Measures	Turn the power OFF and ON once. If it comes back, contact your service provider.
H0711 *	Error message	Power supply relay error
	Cause	The discharge relay on converter card did not turn ON
	Measures	Turn the power OFF and ON once
H0720 *	Error message	Power supply watch dog
	Cause	The converter software process did not end within the specified time.
	Measures	Turn the power OFF and ON once. If it comes back, contact your service provider.
H0730 *	Error message	Power supply rush relay fusing
	Cause	The rush resistance short-circuit relay did not turn OFF.
	Measures	Turn the power OFF and ON once. If it comes back, contact your service provider.
H0740 *	Error message	Power supply main circuit error
	Cause	The charge operation of the main circuit capacitor is not normal. Connection of the external emergency stop has the mistake.
	Measures	Turn the power OFF and ON once. Confirm that the power supply voltage is in the specification value and the connection of the external emergency stop is correct. If it comes back, confirm the time of occurrence of this error being "servo ON/OFF", or being "power supply OFF/ON", and contact your service provider
H0742	Error message	Power supply main circuit error
	Cause	A main circuit voltage has decreased because of Safety relay.
	Measures	Check for errors in the Safety relay. Confirm whether there is any problem in wiring of the external emergency stop switch. Refer to the "Examples of safety measures" given in separate "Standard Specifications Manual" for external emergency stop switch wiring. If it comes back, contact to your service provider.
H0743 *	Error message	Power supply main circuit error3.
	Cause	A main circuit voltage has decreased because of contactor fail.
	Measures	Turns off the power once and turns on on the power supply again. Confirm power supply voltage and the connection of the external emergency stop. When it comes back, contact to the dealer.
H0750 *	Error message	Power supply memory error
	Cause	An error in the memory circuit of converter or AD converter was detected.
	Measures	Turn the power OFF and ON once. If it comes back, contact your service provider.

Error No.	Error cause and measures	
H0760 *	Error message	Power supply error
	Cause	An error was detected in the data comm. with the power supply
	Measures	Turn the power OFF and ON once
H078n * (n indicates the axis number (1 to 8).)	Error message	Servo amplifier watch dog
	Cause	The servo amplifier software process is not operating correctly.
	Measures	Turn the power OFF and ON once. If it comes back, contact your service provider.
H079n * (n indicates the axis number (1 to 8).)	Error message	Servo amplifier board error
	Cause	An error was detected in the servo amplifier's PCB.
	Measures	Turn the power OFF and ON once. If it comes back, contact your service provider.
H080n * (n indicates the axis number (1 to 8).)	Error message	Servo amplifier clock error
	Cause	An error was detected in the servo amplifier's clock.
	Measures	Turn the power OFF and ON once. If it comes back, contact your service provider.
H081n * (n indicates the axis number (1 to 8).)	Error message	Servo amplifier undervoltage
	Cause	The PN bus voltage dropped to 200V or less. Momentary power failure may have occurred.
	Measures	Check the primary voltage.
H0820 * H082n * (n indicates the axis number (1 to 8).)	Error message	Motor ground fault
	Cause	A motor ground fault was detected. A connection or conductance error may have occurred in the motor cable.
	Measures	Turn the power OFF and ON once. If it comes back, contact your service provider.
H083n * (n indicates the axis number (1 to 8).)	Error message	Servo amplifier overvoltage
	Cause	The PN bus voltage rose to 400V or more.
	Measures	Check the primary power supply voltage. Turn the power OFF and ON once.
H0840 *	Error message	Instantaneous power failure (SRV)
	Cause	A power shutdown status of 50 msec or longer has occurred.
	Measures	Check the power voltage. Turn the power OFF and ON once.
H0850 *	Error message	Power supply voltage incorrect
	Cause	The input power (L1, L2, L3) has an open phase, the voltage is not within the specifications, or the 100V/200V specifications changeover setting is incorrect.
	Measures	Check the power connection, power state or the setting.
H0860	Error message	Power supply overvoltage
	Cause	The voltage across the converter's L+ and L- exceeded 410V.
	Measures	Check the power supply connection and power supply state.
H087n * (n indicates the axis number (1 to 8).)	Error message	Encoder thermal error
	Cause	The built-in thermal protector of the serial pulse encoder has been activated.
	Measures	Turn the controller power OFF, wait a while, and then turn ON again. If it comes back, contact your service provider.
H0880 * H088n * (n indicates the axis number (1 to 8).)	Error message	Power module overheat
	Cause	Overheating of the power module regenerative resistor was detected.
	Measures	Turn the controller power OFF, wait a while, and then turn ON again. If it comes back, contact your service provider.
H089n (n indicates the axis number (1 to 8).)	Error message	Servo amplifier motor overheat
	Cause	The position detector's thermal protector activated.
	Measures	Turn the controller power OFF, wait a while, and then turn ON again. Decrease the acceleration/ deceleration time of the operation speed, for instance. Refer to "Detailed explanation of command words"/"Accel (Accelerate)," "Ovrd (Override)" and "Spd (Speed)," or "Detailed explanation of Robot Status Variable"/"M_SetAdl," "M_LdfAct" and "Functions set with parameters"/"JADL (Optimum acceleration/deceleration adjustment rate)" of the Separate Volume, "INSTRUCTION MANUAL/Detailed Explanation of Functions and Operations."
H090n * (n indicates the axis number (1 to 8).)	Error message	Absolute position overspeed
	Cause	It moved 45 mm/sec or faster with the absolute position linear scale during initialization.
	Measures	Turn the power OFF and ON once. If it comes back, contact your service provider.

Error No.	Error cause and measures	
H091n * (n indicates the axis number (1 to 8).)	Error message	Servo amplifier overspeed
	Cause	A speed exceeding the motor's tolerable speed was detected.
	Measures	Turn the power OFF and ON once. If it comes back, contact your service provider.
H0920 * H092n * (n indicates the axis number (1 to 8).)	Error message	Power module overcurrent
	Cause	A servo amplifier or power supply overcurrent was detected. An error was detected in the servo amplifier's gate circuit. A connection or conductance error may have occurred in the motor cable .
	Measures	Confirms the connection of the machine cable and the locomotion-axis cable. If it comes back, contact your service provider.
H093n * (n indicates the axis number (1 to 8).)	Error message	Motor overcurrent
	Cause	An excessive current flowed to the motor, or the A/D converter output is abnormal. An abnormality may have occurred in the connection of the motor's power line.
	Measures	Confirms the connection of the machine cable and the locomotion-axis cable etc. If it comes back, contact your service provider.
H094n (n indicates the axis number (1 to 8).)	Error message	Overload (over weight 1)
	Cause	Operation tight for a motor (operation with high duty) was performed more than fixed time.
	Measures	Decrease the acceleration/deceleration time of the operation speed, for instance. Refer to "Detailed explanation of command words"/"Accel (Accelerate)," "Ovrd (Override)" and "Spd (Speed)," or "Detailed explanation of Robot Status Variable"/"M_SetAdl," "M_LdfAct" and "Functions set with parameters"/"JADL (Optimum acceleration/deceleration adjustment rate)" of the Separate Volume, "INSTRUCTION MANUAL/Detailed Explanation of Functions and Operations." Confirms that conveyance conditions (hand mass, work-piece mass) are less than specification values. When it comes back, contact to the dealer.
H095n (n indicates the axis number (1 to 8).)	Error message	Overload (over weight 2)
	Cause	The maximum output current continued for more than one second.
	Measures	Check the load weight and the robot pressing, etc. Confirms that conveyance conditions (hand mass, work-piece mass) are less than specification values. When it comes back, contact to the dealer.
H096n (n indicates the axis number (1 to 8).)	Error message	Excessive error 1
	Cause	The position error exceeded at servo ON. Moreover, this error may occur during the emergency-stop deceleration.
	Measures	· Check the load weight and press, etc. Confirms the connection of the machine cable and the locomotion-axis cable etc. If the surrounding temperature is low, or starting after stopping operation for an extended period of time, perform running-in operation at low speed or use the warm-up operation mode. · When hand offset is long and acceleration-and-deceleration control is fixed or tracking is active in RH-20FH series, please reduce the acceleration and deceleration speeds (Accel command) and movement speed (Ovrd command). Refer to separate "Instruction Manual/Detailed Explanation of Functions and Operations" for details of each command. (This error may occur during the emergency-stop deceleration.) · While operation is performed in the compliance mode of the joint coordinate system, if the Excessive error 1 (H096n) occurs, increase the set value of parameter CMPJCLL to suppress this error. Refer to "Detailed explanation of command words"/"Cmp Jnt (Compliance Joint)" and "Movement parameter"/"CMPJCLL (Current Limit Level for Cmp Jnt)" given in separate "INSTRUCTION MANUAL/Detailed explanation of functions and operations". (To use this function, the controller software version R4b/S4b or later is required.)
H097n (n indicates the axis number (1 to 8).)	Error message	Excessive error 2
	Cause	The position error exceeded at servo OFF.
	Measures	Check the moving robot arm by something power. When it comes back, contact to the dealer.
H098n (n indicates the axis number (1 to 8).)	Error message	Excessive error 3
	Cause	Abnormal motor power line connection.
	Measures	Check the connection of motor power line. When the excessive error 1 was detected, the current of the motor is off.

Error No.	Error cause and measures	
H101n (n indicates the axis number (1 to 8).)	Error message	Collision detection
	Cause	A collision was detected.
	Measures	<p>1) If the robot has stopped by interference with peripheral equipment, move the arm to part from peripheral equipment using jog operation. Depending on the level of collision, the collision detection error may occur again. In that case, turn on the servo power again and do jog operation. If it still recurs, release the brake and move the arm by hand.</p> <p>2) If this error occurs without having collided, please adjust the collision detection level. If collision is detected incorrectly during automatic operation, enlarge the setting value of the parameter (COLLVL) corresponding to axis. If collision is detected incorrectly during jog operation, enlarge the setting value of the parameter (COLLVLJG) corresponding to axis. However, since the detection level drops by enlarging the set value, don't enlarge too much. And, the incorrect detection can be reduced when setup value of parameter (HNDDATn、WRKDATn) is correct.</p> <p>3) If the speed excessive error has occurred at the same time, the torque alteration by rapid speed change may be detected as a collision state. Remove other causes of the error and confirm movement again.</p> <p>4) In case of operation under the environment of low temperature or after the long term stoppage, the collision detection error may occur by viscous transmutation of the grease used. In such a case, operate by accustoming at low speed (warm-up), or use the warm-up operation mode.</p>
H102n (n indicates the axis number (1 to 8).)	Error message	Servo AMP over-regeneration
	Cause	The additional axis exceeded the regenerative performance limit.
	Measures	Check the regenerative capacity and parameters for the additional axis. If it comes back, contact your service provider. Regeneration resistance may be disconnected.
H1030 *	Error message	Power supply over-regeneration
	Cause	The converter's regenerative performance limit was exceeded.
	Measures	Wait at least 15 minutes in the power ON state, and then turn the power OFF and ON. If it comes back, contact your service provider. Regeneration resistance may be disconnected.
H104n * (n indicates the axis number (1 to 8).)	Error message	Encoder init communication error
	Cause	<p>1) An abnormality may have occurred in the position detector cable connection.</p> <p>2) The fuse (4A fuse) installed at the bottom of the 24 V power supply circuit in the controller may have blown out. For the fuse blowout, the emergency stop made by the customer may be the cause, or there may be a ground fault or short circuit with the 24 V power supply in the wiring of a door switch, enabling device, etc.</p>
	Measures	<p>1) Turn the power OFF and ON once. If it comes back, contact your service provider.</p> <p>2) Investigate and correct the ground fault or short circuit portion in the wiring made by the customer. Then, replace the fuse inside the controller. Refer to Page 44, "Fig.2-2 : Fuse (F8) exchange place" for details. (On details of the fuse, contact the manufacturer.)</p>
H105n * (n indicates the axis number (1 to 8).)	Error message	Encoder init communication error
	Cause	Initial communication with the encoder was not possible
	Measures	Check the encoder cable connection
H106n * (n indicates the axis number (1 to 8).)	Error message	Encoder communication error
	Cause	Communication between the encoder and detector was cut off
	Measures	Check the encoder cable connection
H107n * (n indicates the axis number (1 to 8).)	Error message	Encoder communication error
	Cause	<p>1) Communication with the position detector was cut off.</p> <p>2) The fuse (4A fuse) installed at the bottom of the 24 V power supply circuit in the controller may have blown out. For the fuse blowout, the emergency stop made by the customer may be the cause, or there may be a ground fault or short circuit with the 24 V power supply in the wiring of a door switch, enabling device, etc.</p>
	Measures	<p>1) Confirms the signal cable of the machine cable and the locomotion-axis cable etc. If it comes back, contact your service provider.</p> <p>2) Investigate and correct the ground fault or short circuit portion in the wiring made by the customer. Then, replace the fuse inside the controller. Refer to Page 44, "Fig.2-2 : Fuse (F8) exchange place" for details. (On details of the fuse, contact the manufacturer.)</p>
H108n * (n indicates the axis number (1 to 8).)	Error message	Servo AMP communication error
	Cause	An abnormality may have occurred in the communication cable connection.
	Measures	Turn the power OFF and ON once. If it comes back, contact your service provider. CR750-Q/CR751-Q: Confirms the connection between the robot CPU system and the drive unit.

Error No.	Error cause and measures	
H1090 * H109n * (n indicates the axis number (1 to 8).))	Error message	Servo AMP initialization error
	Cause	An abnormality may have occurred in the servo axis settings (parameters, rotary switches).
	Measures	Turn the power OFF and ON once. If it comes back, contact your service provider. CR750-Q/CR751-Q: Confirms the connection between the robot CPU system and the drive unit. Using the additional axis: Confirms the axis setting switch, cable connection with robot controller, setting parameter, condition of power supply of additional axis amplifier, type of additional axis amplifier etc.
H1100 *	Error message	Servo AMP communication error
	Cause	An abnormality may have occurred in the communication cable connection.
	Measures	Turn the power OFF and ON once. If it comes back, contact your service provider. Confirms the cable connection with robot controller and the condition of power supply of additional axis amplifier.
H111n (n indicates the axis number (1 to 8).))	Error message	SRV-AMP comm. error
	Cause	A communication error was detected between the servo amplifier and PC.
	Measures	Check the communication cable connection and conductivity. If it comes back, contact your service provider.
H112n * (n indicates the axis number (1 to 8).))	Error message	Encoder ABS position data lost
	Cause	The absolute position data in the position detector was lost. The voltage of the robot-arm or additional axis' s backup battery may be dropping.
	Measures	Please set up the origin by ABS method after replacing the batteries. (Since position data can be perfectly restored if the origin is set up by the ABS method, re-teaching is unnecessary.)  <Software version R4b (CR750-Q/CR751-Q controller)/S4b (CR750-D/CR751-D controller) or later> If the voltage of robot battery is low, reset the error, and set up the origin by ABS method. Then, the robot can be operated without replacing the battery. However, this error occurs again when the controller is returned on. It is recommended to replace the battery at the earliest opportunity.
H113n * (n indicates the axis number (1 to 8).))	Error message	Encoder per rotation data error
	Cause	An error was detected in the position detector's one rotation data.
	Measures	Turns off the power supply once and turns on again. If it comes back, contact your service provider.
H114n * (n indicates the axis number (1 to 8).))	Error message	SRV-AMP Comm. data error (CRC)
	Cause	A CRC error was detected in the data from servo amplifier.
	Measures	Turns off the power supply once and turns on again. If it comes back, contact your service provider.
H115n * (n indicates the axis number (1 to 8).))	Error message	Large command position
	Cause	The command position from the RC is abnormally large.
	Measures	Turns off the power supply once and turns on again. If it comes back, contact your service provider.
H116n * (n indicates the axis number (1 to 8).))	Error message	SRV-AMP Comm. error (frame)
	Cause	An error was detected in the communication frame from servo amplifier.
	Measures	Turns off the power supply once and turns on again. If it comes back, contact your service provider.
H117n * (n indicates the axis number (1 to 8).))	Error message	SRV-AMP Comm. error (info)
	Cause	An error was detected in the communication information from the RC.
	Measures	Check the communication cable connection and conductivity. If it comes back, contact your service provider.
H118n * (n indicates the axis number (1 to 8).))	Error message	Servo amplifier feedback error 1
	Cause	Pulses skipped in the position detector's feedback signal.
	Measures	Check the detector cable connection and conductivity. If it comes back, contact your service provider.
H119n * (n indicates the axis number (1 to 8).))	Error message	Servo amplifier feedback error 2
	Cause	Displacement occurred in the feedback amounts between the detectors on the motor edge and on the machine edge.
	Measures	Check the detector cable connection and conductivity. If it comes back, contact your service provider.
H1200 *	Error message	SRV-AMP Comm. data error (CRC)
	Cause	A CRC error was detected in the communication data from the servo amplifier.
	Measures	Turns off the power supply once and turns on again. If it comes back, contact your service provider.

Error No.	Error cause and measures	
H121n * (n indicates the axis number (1 to 8).)	Error message	SRV-AMP Comm. data error (ID)
	Cause	A data ID error was detected in the communication data from the servo amplifier.
	Measures	Turns off the power supply once and turns on again. If it comes back, contact your service provider.
H122n * (n indicates the axis number (1 to 8).)	Error message	SRV-AMP Comm. data error (axis No)
	Cause	An axis No. error was detected in the communication data from the servo amplifier.
	Measures	Turns off the power supply once and turns on again. If it comes back, contact your service provider.
H123n * (n indicates the axis number (1 to 8).)	Error message	SRV-AMP Comm. data error (SubID)
	Cause	A Sub ID error was detected in the communication data from the servo amplifier.
	Measures	Turns off the power supply once and turns on again. If it comes back, contact your service provider.
H1240 *	Error message	SRV-AMP Comm. data error (frame)
	Cause	An No. of received frames error was detected in the communication data from the servo amplifier.
	Measures	Turns off the power supply once and turns on again. If it comes back, contact your service provider.
H125n * (n indicates the axis number (1 to 8).)	Error message	Servo amplifier parameter error
	Cause	An error was detected in the servo parameter.
	Measures	Confirms whether the type displayed on the rated name plate of controller and T/B is the same. If different, restores the type data (backup data). If it comes back, contact your service provider.
C126n (n indicates the axis number (1 to 8).)	Error message	Encoder communication error
	Cause	Initial communication could not be established with the low-speed serial type absolute position linear scale.
	Measures	Check the detector cable connection and conductivity. If it comes back, contact your service provider.
C127n (n indicates the axis number (1 to 8).)	Error message	Encoder communication error
	Cause	The serial data of absolute position was abnormally transmitted.
	Measures	Check the detector cable connection and conductivity. Moreover, confirms carefully that the moving position of the robot has not deviated, and if it has deviated, sets up the origin again. Refer to separate "Instruction Manual/ROBOT ARM SETUP & MAINTENANCE" for operation method. If it comes back, contact your service provider.
C128n (n indicates the axis number (1 to 8).)	Error message	Encoder serial format error
	Cause	Absolute position serial data format was incorrect.
	Measures	Check the detector cable connection and conductivity. Moreover, confirms carefully that the moving position of the robot has not deviated, and if it has deviated, sets up the origin again. Refer to separate "Instruction Manual/ROBOT ARM SETUP & MAINTENANCE" for operation method. If it comes back, contact your service provider.
C129n (n indicates the axis number (1 to 8).)	Error message	Absolute position fluctuation
	Cause	The absolute position data fluctuated when the power was turned ON.
	Measures	Check whether the axis moved due to arm dropping or external force when the power was turned ON.
C130n (n indicates the axis number (1 to 8).)	Error message	Servo AMP MP scale F/B error
	Cause	Excessive displacement was detected in the feedback amounts between the detector and the MP scale.
	Measures	Turn the power OFF and ON once. If it comes back, contact your service provider.
C131n (n indicates the axis number (1 to 8).)	Error message	Servo AMP MP scale offset error
	Cause	Excessive displacement was detected in the feedback amounts between the detector and the MP scale.
	Measures	Turn the power OFF and ON once. If it comes back, contact your service provider.
C132n (n indicates the axis number (1 to 8).)	Error message	Multi-rotation data error
	Cause	An error was detected in the position detector's multi-rotation data.
	Measures	When the power supply is turned on next time, the current position data may not be correctly detected. Please re-turn on the controller power supply and set up the origin by ABS method (Even if this warning occurs, unless the controller is re-turned on, it can operate perfectly. However, when re-turning on the controller, the position gap may occur. Please be sure to set up the origin by ABS method after re-turning on the controller power supply. Current position data returns to the normal position before error occurrence.) When it comes back, contact to the dealer.

Error No.	Error cause and measures	
C133n (n indicates the axis number (1 to 8).)	Error message	Encoder battery voltage low
	Cause	The battery voltage supplied to the position detector dropped.
	Measures	Replace the backup battery. For more information about the replacement procedure, refer to the separate volumes, "Instruction Manual/Robot Arm Setup to Maintenance". Even if this warning occurs, unless the controller is re-turned on, it can operate perfectly. However, if the battery consumption is intense, the Encoder ABS position data lost error (H112n) may occur when the controller is re-turned on.
C134n (n indicates the axis number (1 to 8).)	Error message	Over-regeneration warning
	Cause	The regenerative level of the additional axis has risen to 80% or more.
	Measures	Check the regenerative capacity and parameters for the additional axis. If it comes back, contact your service provider. Regeneration resistance may be disconnected.
C135n (n indicates the axis number (1 to 8).)	Error message	Overload warning
	Cause	The overload level reached 95% or more.
	Measures	Check the load weight and the robot for collisions, etc.
H136n * (n indicates the axis number (1 to 8).)	Error message	Absolute position counter error
	Cause	The counter of absolute position is illegal.
	Measures	Confirm whether the connection of encoder cable and the battery voltage of arm is falling.
C137n (n indicates the axis number (1 to 8).)	Error message	Illegal parameter (servo)
	Cause	A parameter was set exceeding the setting range.
	Measures	The parameter has not been changed. Reset the correct value. If it comes back, contact your service provider.
C138n (n indicates the axis number (1 to 8).)	Error message	Removing control axis (servo)
	Cause	An instruction to remove the axis was issued by the controller.
	Measures	Cancel the instruction of removing axis.
H1390	Error message	Emergency stop (Servo amplifier)
	Cause	The emergency stop command has been input from the RC
	Measures	Release the emergency stop state
C1400	Error message	regeneration(AUX) frequency over
	Cause	Regeneration at the limit has occurred frequently
	Measures	Check the regeneration capacity
H1410	Error message	Instantaneous power failure (SRV)
	Cause	Momentary power failure of 25 msec or longer has occurred.
	Measures	Confirm the power supply of addition axis servo amplifier.
C1420	Error message	Over-regeneration warning
	Cause	The regeneration level reached 80% or more.
	Measures	Lower the robot's movement speed. If it comes back, contact your service provider. Regeneration resistance may be disconnected.
C1430	Error message	Servo amplifier main circuit OFF
	Cause	The servo turned ON while the main circuit power was OFF
	Measures	Turn the main circuit power ON
H144n * (n indicates the axis number (1 to 8).)	Error message	System error (servo 2)
	Cause	Trouble occurred in the current processing processor.
	Measures	Turn the power OFF and ON once. If it comes back, contact your service provider.
H1460 *	Error message	Power supply overcurrent
	Cause	Overcurrent in the power module in the power supply.
	Measures	Check the AC power line. If it comes back, contact your service provider.
H1470 *	Error message	Frequency error
	Cause	AC frequency is out of range.
	Measures	Check the AC power line frequency. If it comes back, contact your service provider.

Error No.	Error cause and measures	
H1480 *	Error message	Power supply parameter error
	Cause	Illegal at the power supply parameter
	Measures	Set the correct parameter
H1490 *	Error message	Power supply Power module overheat.
	Cause	The temperature protection function of the power module operated.
	Measures	Clean up or replaces the air filters. When it comes back, contact to the dealer.
H1491	Error message	Illegal converter thermal servo AMP.
	Cause	Overheating of servo AMP converter.
	Measures	Turn the power OFF, wait a while, and then turn ON again.
H150n * (n indicates the axis number (1 to 8).)	Error message	Motor combination error
	Cause	The servo motor which does not correspond to addition axis servo amplifier is connected.
	Measures	Confirm the specifications of servo amplifier and the motor.
H151n * (n indicates the axis number (1 to 8).)	Error message	SRV-AMP USB comm. error
	Cause	A communication error was detected between the servo amp and PC
	Measures	Check the communication cable connection and conductivity
H152n * (n indicates the axis number (1 to 8).)	Error message	Servo motor output watt over
	Cause	The output wattage of the servo motor exceeded ratings
	Measures	Lower the rotation speed of the servo motor
H154n * (n indicates the axis number (1 to 8).)	Error message	Communication error between units
	Cause	The transmission data between servo amplifier units is illegal
	Measures	Check the communication cable connection and conductivity
H1550 *	Error message	Emergency stop is a breakdown
	Cause	The external emergency stop input is illegal
	Measures	Turn the power OFF and ON once. When it comes back, contact to the dealer.
H156n (n indicates the axis number (1 to 8).)	Error message	Excessive error 4
	Cause	The axis moved while executing servo ON processing.
	Measures	If it comes back, contact your service provider.
H157n (n indicates the axis number (1 to 8).)	Error message	Non-registered servo error. (This error may be caused by the error on the amplifier for additional axis.)
	Cause	A non-registered servo alarm occurred.
	Measures	Confirms the code by LED of servo additional axis amplifier, and refer to the instruction manual of servo amplifier. If the alarm cannot be reset, turn the power OFF and ON. If it comes back, contact your service provider.
C158n (n indicates the axis number (1 to 8).)	Error message	Non-registered servo warning. (This caution may be caused by the warning on the amplifier for additional axis.)
	Cause	A non-registered servo warning occurred.
	Measures	Confirms the code by LED of servo additional axis amplifier, and refer to the instruction manual of servo amplifier. If the alarm cannot be reset, turn the power OFF and ON. If it comes back, contact your service provider.
H1600 *	Error message	Mechanism un-setting.
	Cause	The mechanism is not set up.
	Measures	Set up one or more of mechanism. If this alarm occur after the restoring the data of controller check the restored data. If it comes back, contact your service provider.
H1610 *	Error message	System error (illegal MEMECH)
	Cause	The mechanism module name is illegal or not registered.
	Measures	Correctly set. If it comes back, contact your service provider. If it comes back, contact your service provider.
C1620	Error message	Illegal robot No.
	Cause	When specifying the mechanism number by the external communications protocol, the mechanism number not existing was specified.
	Measures	Specify the existing mechanism number.



Error No.	Error cause and measures	
C1630	Error message	Cannot servo ON (during error)
	Cause	The servo cannot be turned ON during a servo error.
	Measures	Reset the servo error before turning the servo ON.
C1640	Error message	Cannot servo ON (DEADMAN OFF)
	Cause	The servo cannot be turned ON while the enable switch is OFF.
	Measures	Turn the enable switch ON before turning the servo ON.
C1650	Error message	Cannot servo ON (brake OFF)
	Cause	The servo cannot be turned ON when there is an axis with the brakes released.
	Measures	Lock the brakes for all axes before turning the servo ON.
C1660	Error message	Cannot servo ON (SRVON process)
	Cause	The servo cannot be turned ON during the servo ON process.
	Measures	Operate it after servo ON process is finished.
C1670	Error message	Cannot servo ON (SRVOFF process)
	Cause	The servo OFF process is being carried out.
	Measures	Operate it after servo OFF process is finished.
H1680	Error message	Cannot servo ON (timeout)
	Cause	The servo did not turn ON within the specified time.
	Measures	Turn the power supply OFF and ON once. If it comes back, confirm that power supply voltage is in the specification value, and connection of the external emergency stop is correct. And, when using the addition axis, confirm that the power supply voltage to the servo amplifier of addition axes is in the specification value and connection of AXMC is correct. If it comes back, contact your service provider.
H1681	Error message	Unexpected servo OFF
	Cause	The servo turned OFF unexpectedly.
	Measures	Confirm that primary power supply voltage is in the specification value and wiring of the external emergency stop line is correct. When using the additional axis, confirms whether the alarm occur on the additional axis. If it comes back, contact your service provider.
H1682	Error message	Servo ON Timeout (Safety relay).
	Cause	A main circuit voltage did not rise because of Safety relay.
	Measures	Check for errors in the Safety relay. Confirm that wiring of the external emergency stop line is correct. Confirm whether there is any problem in wiring of the external emergency stop switch. Refer to the "Examples of safety measures" given in separate "Standard Specifications Manual" for external emergency stop switch wiring. Please confirm whether in use of addition axis, there is any failure in the servo amplifier for addition axes. If it comes back, contact to your service provider.
H1683	Error message	Servo ON Timeout. (Contactor)
	Cause	A main circuit voltage did not rise because of contactor welded.
	Measures	Turns off the power supply once and turns on again. Confirm that primary power supply voltage is in the specification value and wiring of the external emergency stop line is correct. When it comes back, contact to the dealer.
C1690	Error message	Cannot brake operation (DEADMAN)
	Cause	The servo cannot be turned ON while the enable switch is OFF.
	Measures	Turn the enable switch ON before turning the servo ON.
C1700	Error message	Cannot brake operation (EMG)
	Cause	The brakes cannot be released while the emergency stop is input.
	Measures	Release the emergency stop state before operating.
C1710	Error message	Cannot brake operation (SRVON)
	Cause	The brakes cannot be operated during servo ON.
	Measures	Turn the servo OFF before operating.

Error No.	Error cause and measures	
C1720	Error message	Cannot brake operation (BRK OFF)
	Cause	The brakes cannot be released during the brake release process.
	Measures	Operate it after brake is released.
C1730	Error message	Cannot brake operation (BRK ON)
	Cause	The brakes cannot be locked during the brake lock process.
	Measures	Operate it after brake is locked.
C1740	Error message	Servo parameter change failure
	Cause	Other parameters cannot be changed during the parameter change process.
	Measures	Carry out the parameter change process again.
C1750	Error message	Servo parameter change failure
	Cause	Changes of the servo parameter failed.
	Measures	Carry out the parameter change process again.
C1760	Error message	Illegal origin data
	Cause	The origin setting data is not correct.
	Measures	Set the correct origin setting data. Confirm mistakes such as "1(one)" and "I(alphabet)", or "O(alphabet)" and "0(zero)", etc.
C1770	Error message	Origin setting incomplete
	Cause	The origin is not set.
	Measures	Re-execute after setting the origin.
C1780	Error message	Cannot set origin (illegal axis)
	Cause	The origin was not set simultaneously for the interference axis.
	Measures	Set the origin simultaneously for the interference axis. For example, the J3 axis and the J4 axis of the RH type robot. Please refer to the section of origin setting of separate manual: "ROBOT ARM SETUP & MAINTENANCE" for details.
C1781	Error message	Cannot set origin (SRVON)
	Cause	The origin was set during servo ON.
	Measures	Turn the servo OFF before setting the origin.
H179n *n (n indicates the axis number (1 to 8).)	Error message	Illegal parameter (MEJAR)
	Cause	The parameter (MEAJAR) setting is illegal. Or the setting value of the parameter related to addition axis control have exceeded the controllable operating range.
	Measures	The useful range of the operating range setting parameter (MEAJAR) is -131072.00 to +131072.00. Correct, if the set value is over the range. Or confirm the setting value of the parameter related to addition axis control.
H1800 *	Error message	Illegal parameter (MEMAR)
	Cause	The ABS operation range setting parameter MEMAR setting is incorrect. (Minus side value is larger than "0", or plus side value is smaller than "0")
	Measures	Set the value of the parameter "MEMAR" within the limits.
H1810 *	Error message	Illegal parameter (USERORG)
	Cause	The user origin setting parameter USERORG setting is incorrect.
	Measures	Correct the parameter USERORG.
L182n (n indicates the axis number (1 to 8).)	Error message	Pos. data disagree.Check origin
	Cause	1) Position data changed during power off. 2) The fuse (4A fuse) installed at the bottom of the 24 V power supply circuit in the controller may have blown out. For the fuse blowout, the emergency stop made by the customer may be the cause, or there may be a ground fault or short circuit with the 24 V power supply in the wiring of a door switch, enabling device, etc.
	Measures	1) Check the origin, re-install if shifting. Re-set up the origin only for the axis which deviated by the ABS method. 2) Investigate and correct the ground fault or short circuit portion in the wiring made by the customer. Then, replace the fuse inside the controller. Refer to Page 44, "Fig.2-2 : Fuse (F8) exchange place" for details. (On details of the fuse, contact the manufacturer.)

Error No.	Error cause and measures	
L1830	Error message	JRC. Exceeds the Pos. limit
	Cause	The JRC instruction exceeding the operation range was executed.
	Measures	Check the current position and the operating range.
L184n (n indicates the axis number (1 to 8).)	Error message	JRC Qtt. Setting Too Large
	Cause	The movement amount setting of the JRC is excessive.
	Measures	Correct the JRCQTT parameter.
C1850	Error message	Instantaneous power failure
	Cause	There was the momentary power failure.
	Measures	Check the power supply connection and power supply state.
L1860	Error message	Illegal parameter (TLC)
	Cause	The setting of the TLC parameter that sets the approach direction was incorrect.
	Measures	Correct the TLC parameter. (=X/Y/Z)
H188n * (n indicates the axis number (1 to 8).)	Error message	Jn addition axis amplifier cooling fan stop.
	Cause	The cooling fan of the addition axis amplifier of Jn axis may be out of order.
	Measures	Please replace the cooling fan of addition axis amplifier. * Please also refer to the instruction manual of the servo amplifier of usage.
C189n * (n indicates the axis number (1 to 8).)	Error message	Jn addition axis amplifier cooling fan rev fall.
	Cause	The cooling fan of the addition axis amplifier of Jn axis may be out of order.
	Measures	Please replace the cooling fan of addition axis amplifier. * Please also refer to the instruction manual of the servo amplifier of usage.
C1920	Error message	Cooling fan stopped (pow. sup.)
	Cause	1) The cooling fan of the power supply stopped. 2) The fuse (4A fuse) installed at the bottom of the 24 V power supply circuit in the controller may have blown out. For the fuse blowout, the emergency stop made by the customer may be the cause, or there may be a ground fault or short circuit with the 24 V power supply in the wiring of a door switch, enabling device, etc.
	Measures	1) Confirm the rotation of the power supply cooling fan. 2) Investigate and correct the ground fault or short circuit portion in the wiring made by the customer. Then, replace the fuse inside the controller. Refer to <a href="#">Page 44</a> , "Fig.2-2 : Fuse (F8) exchange place" for details. (On details of the fuse, contact the manufacturer.)
C1940	Error message	Agitating fan stopped
	Cause	1) The fan for agitating inside the robot controller (drive unit) has stopped. 2) The fuse (4A fuse) installed at the bottom of the 24 V power supply circuit in the controller may have blown out. For the fuse blowout, the emergency stop made by the customer may be the cause, or there may be a ground fault or short circuit with the 24 V power supply in the wiring of a door switch, enabling device, etc.
	Measures	1) Confirm rotation of the target cooling fan, and if out of order, replace them. Please refer to <a href="#">Page 45</a> , "Appendix 2: Fan installation place of robot controller (drive unit)." for the fan's mounting place. 2) Investigate and correct the ground fault or short circuit portion in the wiring made by the customer. Then, replace the fuse inside the controller. Refer to <a href="#">Page 44</a> , "Fig.2-2 : Fuse (F8) exchange place" for details. (On details of the fuse, contact the manufacturer.)
H195n	Error message	Additional axis AMP error xx
	Cause	Alarm of the addition axis servo amplifier was detected.
	Measures	Refer to the instruction manuals of addition axis servo amplifier for the details of alarm. "xx" of the error message corresponds to the alarm number of addition axis servo amplifier (MR-J3- □ B). (The error reset methods differ for each alarm number of addition axis servo amplifier.)
C196n	Error message	Additional axis AMP Warning xx
	Cause	Warning of the addition axis servo amplifier was detected.
	Measures	Refer to the instruction manuals of addition axis servo amplifier for the details of warning. "xx" of the error message corresponds to the warning number of addition axis servo amplifier (MR-J3- □ B).
L2000	Error message	The servo is OFF
	Cause	Because servo is turned off, the robot can't move.
	Measures	Turn the servo ON and then restart.

Error No.	Error cause and measures	
L2010	Error message	Pulse output was not possible
	Cause	There is an error in the pulse output designation.
	Measures	Correct the program.
L2020	Error message	Reading external position data
	Cause	A command that cannot be executed while reading the external commands was executed.
	Measures	Correct the program.
L2030	Error message	JOG operation cannot be accepted
	Cause	The JOG operation request was issued when the JOG operation request could not be accepted.
	Measures	Changes the JOG mode after the JOG operation.
H2031 *	Error message	"Illegal parameter(JOGTSJ,JOGJSP)"
	Cause	The parameter JOGTSJ, JOGJSP settings are not correct. [JOGPSP], [JOGJSP] = (element 1, element 2) = (constant high, constant low)
	Measures	Set the set dimension to 5 or less.
H2040	Error message	Teaching position is not correct.
	Cause	Change the teaching position.
	Measures	The work coordinates were not able to be calculated from the teaching position. The cause is the following content. 1. Two points are the same position. 2. Three points line up on the straight line. Confirm and correct the teaching position
L2050	Error message	CPU processing time exceeds
	Cause	Because the function made effective is many at the same time
	Measures	The CPU processing time exceeded the limiting value. Please take measures of either of following. 1. If interference avoidance function is activated, changes some cylinder models into the sphere model, or reduces the number of the models for checking . 2. Invalidate some functions of following. Interference avoidance, User definition area, Free plane limit, Collision detection, Compliance, Tracking, Force sense 3. Reduces the Interrupt definition function currently used by the program.
H2090	Error message	In interference zone n. (n indicates the zone number (1 to 32).)
	Cause	Movement outside the user-defined area "n" range was attempted.
	Measures	Adjust the position.
H211n (n indicates the plane number (1 to 8).)	Error message	Free plane n overrun
	Cause	Movement outside the plane defined with free plane "n" was attempted.
	Measures	Adjust the position.
H212n (n indicates the plane number (1 to 8).)	Error message	Free plane n overrun
	Cause	Movement outside the plane defined with free plane "n" was attempted.
	Measures	Adjust the position.
H2129	Error message	Free plane limit data illegal
	Cause	The free plane data setting value is illegal.
	Measures	The two points are the same in the three points of parameter: SFCnp. The value of parameter: SFCnAT is except "0, 1, -1".
H213n (n indicates the axis number (1 to 8).)	Error message	Jn Speed is excessive (command)
	Cause	The speed instruction value of n axis exceeded the permissible value. When moving by the linear interpolation (or circle interpolation), needs to rotate the motor at the big speed depending on the pose. If the specified speed is large, the speed instruction value to the motor may exceed the permissible value.
	Measures	Please lower moving speed by the Ovrd command and Spd command or change the movement position.
H214n (n indicates the axis number (1 to 8).)	Error message	Jn +ABS limit over
	Cause	The axis "n" + ABS limit was exceeded.
	Measures	Referring to "Operation to Temporarily Reset an Error that Cannot Be Canceled" in the separate volume, "Instruction Manual/Detailed Explanation of Functions and Operations", reset the error and move the axis "n" within the operation range using JOG operation.

Error No.	Error cause and measures	
H215n (n indicates the axis number (1 to 8).)	Error message	Jn -ABS limit over
	Cause	The axis "n" - ABS limit was exceeded.
	Measures	Referring to "Operation to Temporarily Reset an Error that Cannot Be Canceled" in the separate volume, "Instruction Manual/Detailed Explanation of Functions and Operations", reset the error and move the axis "n" within the operation range using JOG operation.
H216n (n indicates the axis number (1 to 8).)	Error message	Jn (+) angle exceeds the limit
	Cause	The axis "n" + Joint limit was exceeded.
	Measures	Adjust the position.
H217n (n indicates the axis number (1 to 8).)	Error message	Jn (-) angle exceeds the limit
	Cause	The axis "n" - Joint limit was exceeded.
	Measures	Adjust the position.
H2181	Error message	X(+) data exceeds the limit
	Cause	The X axis + XYZ limit was exceeded.
	Measures	Adjust the position.
H2182	Error message	Y(+) data exceeds the limit
	Cause	The Yaxis + XYZ limit was exceeded.
	Measures	Adjust the position.
H2183	Error message	Z(+) data exceeds the limit
	Cause	The Z axis + XYZ limit was exceeded.
	Measures	Adjust the position.
H2191	Error message	X(-) data exceeds the limit
	Cause	X(-) data exceeds the limit
	Measures	Adjust the position.
H2192	Error message	Y(-) data exceeds the limit
	Cause	Y(-) data exceeds the limit
	Measures	Adjust the position.
H2193	Error message	Z(-) data exceeds the limit
	Cause	Z(-) data exceeds the limit
	Measures	Adjust the position.
L240n (n: Robot CPU No.)	Error message	Collision avoidance detect (*) Note "(*)": shows the detected model. (the the lower digit of the parameter for the model registry)
	Cause	A collision avoidance was detected
	Measures	Release the collision avoidance state
L241n (n: Robot CPU No.)	Error message	Collision avoidance detect (*) Note "(*)": shows the detected model. (the the lower digit of the parameter for the model registry)
	Cause	A collision avoidance was detected
	Measures	Release the collision avoidance state
L2420	Error message	Collision avoidance comm. error
	Cause	Collision avoidance comm. error
	Measures	Check the robot controller
L2421	Error message	A lot of colli. avoidance models
	Cause	A lot of collision avoidance models
	Measures	Reduce the collision avoidance models
L2500	Error message	Tracking encoder data error
	Cause	An error was detected in the data of tracking encoder.
	Measures	1) The conveyor rotates at the fixed velocity. 2) The connection of the encoder. 3) The earth of the earth wire.
L2510	Error message	Tracking parameter reverses
	Cause	Tracking parameter[EXCRGM*] Setting value reverses
	Measures	Check the parameter[EXCRGM*] value.

Error No.	Error cause and measures	
L2520	Error message	Tracking parameter is range over
	Cause	Tracking parameter[TRBUF] Setting value is range over. Setting range: element 1=1-8, element 2=1-64
	Measures	Check the parameter[TRUBF] value.
L2530	Error message	There is no area where data is written.
	Cause	There is no area where data is written.
	Measures	Please read the data by using TrRd
L2540	Error message	There is no read data.
	Cause	There is no read data.
	Measures	Please use TrRd after executing TrWrt.
L2560	Error message	Illegal parameter of Tracking.
	Cause	The value of the parameter: EXTENC is outside the range. setting range: 1-8.
	Measures	Please check the value of parameter.
L2570	Error message	Installation slot error.
	Cause	Q173DPX is installed in slot 0-2 of a basic base.
	Measures	Install Q173DPX to slot 3-11.
L2601	Error message	Start pos. exceeds the limit
	Cause	The start position is outside the operation range.
	Measures	Adjust the position.
L2602	Error message	DSTN pos. exceeds the limit
	Cause	The target position is outside the operation range.
	Measures	Adjust the position.
L2603	Error message	Med pos. data exceeds the limit
	Cause	The intermediate position is outside the operation range.
	Measures	Adjust the position.
L2700	Error message	Cmp error (different mode)
	Cause	The designated mode is different from the current mode.
	Measures	Execute Cmp Off and then designate.
C2710	Error message	Cmp error (displacement)
	Cause	The displacement magnitude of the compliance operation exceeded the specified value.
	Measures	Correct the program, position or other item so that the displacement magnitude can be reduced.
H2720	Error message	Cmp error (joint angle)
	Cause	Cmp Command exceeds the limit of a joint angle.
	Measures	Adjust the position data or reduce the displacement.
C272n (n indicates the axis number (1 to 8).)	Error message	Cmp error (Jn joint angle)
	Cause	Cmp Command exceeds the limit of joint "n" axis
	Measures	Change the position data or reduce displacement.
C273n (n indicates the axis number (1 to 8).)	Error message	Cmp error (Jn axis speed)
	Cause	Cmp Command exceeds the limit of speed of joint "n" axis.
	Measures	Change the position data or slow down.
C2740	Error message	Cmp error (coordinates conv.)
	Cause	An error was detected in the coordinates conversion of Cmp command.
	Measures	Adjust the position data.
L2750	Error message	Cannot execute while tracking
	Cause	Cannot execute while tracking
	Measures	Execute Trk Off and then execute
	Error message	Cannot invalidate F.Ctrl (Trk)
	Cause	Force control cannot be invalidated while executing tracking
	Measures	Please invalidate the tracking function

Error No.	Error cause and measures	
L2800	Error message	Illegal position data
	Cause	This may occur for a position to which the robot cannot reach.
	Measures	Adjust the position.
L2801	Error message	Illegal position data (start)
	Cause	This may occur for a starting position to which the robot cannot reach.
	Measures	Adjust the position.
L2802	Error message	Illegal position data (dstn)
	Cause	This may occur for a ending position to which the robot cannot reach.
	Measures	Adjust the position.
L2803	Error message	Illegal assisting position data (intmed)
	Cause	The intermediate path at the straight line interpolation and the route at circle interpolation are the position which the robot cannot move.
	Measures	Confirm the error occurrence line and confirm that there is no position which the robot cannot move. And please correct the data of starting position, midway position, or ending position .
L2810	Error message	Posture flag is disagree
	Cause	The structure flag of the start point and end point don't match.
	Measures	Adjust the position data.
H2820	Error message	Illegal Accel ratio
	Cause	This occurs when the acceleration/deceleration ratio is too small.
	Measures	Adjust the acceleration/deceleration ratio to a larger value.
H2830	Error message	System error (ipol posture type)
	Cause	The Type argument of the Mov instruction was set to -1 or a similar value.
	Measures	Change the Type argument of the Mov instruction to a correct value (0, 1, etc).
H2840	Error message	System error (ipol parameters)
	Cause	The parameter may have been damaged.
	Measures	If it comes back, contact your service provider.
H2850	Error message	System error (ipol norm)
	Cause	The norm is illegal. A problem occurred in internal computation processing.
	Measures	If it comes back, contact your service provider.
H2860	Error message	System error (ipol type)
	Cause	An illegal interpolation process method is being used. A problem occurred in internal computation processing.
	Measures	If it comes back, contact your service provider.
H2870	Error message	System error (ipol data undef)
	Cause	The interpolation position data has not been defined. A problem occurred in internal computation processing.
	Measures	If it comes back, contact your service provider.
H2880 *	Error message	System error (ipol data area)
	Cause	The memory is insufficient for the inside operation.
	Measures	If it comes back, contact your service provider.
H2890	Error message	System error (undefined err)
	Cause	An undefined error number was generated in internal computation processing.
	Measures	If it comes back, contact your service provider.
L2900	Error message	System ERROR M00 to M04
	Cause	An error occurred in the internal processing.
	Measures	If it comes back, contact your service provider.
L3100	Error message	PROC stack over
	Cause	For example, if it jumped by GoSub but did not return by the Return command, or if it escaped by GoTo using the For and Next commands, stack memory decreased gradually.
	Measures	Correct so that in the case of GoSub, return by Return, and in the case of For and Next, do not exit by GoTo.

Error No.	Error cause and measures	
L3110	Error message	Arg. value range over
	Cause	Arg. value is outside range
	Measures	Please confirm the range of the argument and set a correct value
L3120	Error message	No. of arg. is over
	Cause	No. of argument is over
	Measures	Please confirm the range of the argument and set a correct value
L3130	Error message	COM file is already opened
	Cause	Opening of a file already opened was attempted.
	Measures	Check the file No. and re-execute.
L3140	Error message	Can't open COM file
	Cause	The file cannot be opened.
	Measures	Check the file No. and re-execute.
L3150	Error message	Cannot Print (INPUT mode)
	Cause	The file open mode is INPUT, so writing is not possible.
	Measures	Check the file No. and open mode, and re-execute.
L3170	Error message	Cannot Input (OUTPUT mode)
	Cause	The file open mode is OUTPUT, so writing is not possible.
	Measures	Check the file No. and open mode, and re-execute.
L3180	Error message	System error (array range over)
	Cause	System error (array range over)
	Measures	If it comes back, contact your service provider
L3200	Error message	This file is read only
	Cause	The file cannot be read.
	Measures	Check the contents of the file.
L3210	Error message	This variable is write protected
	Cause	Writing of this variable is prohibited.
	Measures	Check the variable protection setting.
L3220	Error message	Nesting over
	Cause	A nest-over error occurred in If of the If instruction or For of the For instruction.
	Measures	Correct the program and re-execute.
L3230	Error message	For Next statements unmatched
	Cause	The No. of For and Next statements do not match.
	Measures	Correct the program and re-execute.
L3240	Error message	"Nesting over (For, While)"
	Cause	The No. of nesting stages exceeded 16 stages (For, While).
	Measures	Correct the program.
L3250	Error message	While WEnd statements unmatched
	Cause	The No. of While and WEnd statements do not match.
	Measures	Correct the program and re-execute.
L3251	Error message	Number of jump destination exceeds 32
	Cause	The number of branches defined exceeded 32.
	Measures	Correct the program and re-execute.
L3252	Error message	If EndIf statements unmatched
	Cause	If EndIf statements unmatched.
	Measures	Correct the program and re-execute.
L3253	Error message	"Nesting over (If, EndIf)"
	Cause	The No. of nesting stages exceeded 8 stages (If).
	Measures	Correct the program and re-execute.



Error No.	Error cause and measures	
L3254	Error message	Select - End Select statements unmatched
	Cause	Select - End Select statements unmatched.
	Measures	Correct the program and re-execute.
L3255	Error message	If Else statements unmatched
	Cause	If Else statements unmatched.
	Measures	Correct the program and re-execute.
L3260	Error message	Cannot exec for all slots
	Cause	Execution with all slots designated is not possible.
	Measures	Designate an individual slot and try again.
L3270	Error message	The command size is exceeded
	Cause	The command size is exceeded.
	Measures	Specify within single-byte 256 characters.
L3280	Error message	Cannot execute without GetM
	Cause	The command you attempted to execute cannot be executed without GetM. Or, a non-existing mechanical number was specified.
	Measures	Execute it after executing the ReM and GetM commands in another task slot.
L3281	Error message	Cannot execute during RUN
	Cause	Cannot execute during operation.
	Measures	Cannot execute during operation.
L3282	Error message	"Can't RUN (not select, attribute)"
	Cause	The program is not selected or the attribute is illegal.
	Measures	Load the program into the specified task slot. Or, change the program attributes.
L3285	Error message	Cannot execute (RUN or WAI)
	Cause	can't execute in the state of stopping or executing.
	Measures	Reset the program (cancel the abort status).
L3286	Error message	Program is empty
	Cause	Execution of an empty program was attempted.
	Measures	Make the program or select the correct program.
L3287	Error message	Cannot execute (ERROR ALWAYS)
	Cause	This command cannot be used when the start conditions are ERROR and ALWAYS.
	Measures	Correct the program.
L3288	Error message	Cannot execute while editing
	Cause	That program cannot be executed because it is being edited.
	Measures	Finish editing the program first, and then start it.
L3289	Error message	Program does not exist (SLT*)
	Cause	The program designated in the slot table does not exist.
	Measures	Correct the slot parameter.
L3290	Error message	System slot cannot be executed
	Cause	The system slot cannot be executed.
	Measures	Check whether another slot (user slot) is being operated.
L3300	Error message	User slot cannot be executed
	Cause	A user slot cannot be executed.
	Measures	Check whether the system slot is being operated.
L3310	Error message	Cannot execute XRun (RUNing)
	Cause	XRun is not possible as the designated slot is operating.
	Measures	Stop the specification slot, and execute.
L3320	Error message	Cannot execute XRun (empty)
	Cause	XRun is not possible as the program has not been selected.
	Measures	Specify program name to the argument or execute XLoad.

Error No.	Error cause and measures	
L3330	Error message	Cannot execute XStp (empty)
	Cause	XStp is not possible as the program has not been selected.
	Measures	correct the program, and execute.
L3340	Error message	Cannot execute XRst (empty)
	Cause	XRst is not possible as the program has not been selected.
	Measures	Resetting is possible in the state of waiting only.
L3350	Error message	Cannot execute XRst (Running)
	Cause	Xrst is not possible as the program is executing.
	Measures	Stop execution, and do it.
L3360	Error message	Cannot execute XLoad (not PSA)
	Cause	XLoad cannot be executed when the program cannot be selected.
	Measures	Execute XRst, and do it.
L3361	Error message	Can not load the program (SLT*)
	Cause	A non-existing program was specified in the slot parameter (SLTn).
	Measures	A non-existing program was specified in the slot parameter (SLTn).
L3370	Error message	Cannot execute XClr (empty)
	Cause	XClr is not possible as the program has not been selected.
	Measures	XClr can only be executed to enable program selection.
L3380	Error message	Cannot execute XClr (not PSA)
	Cause	Program selection is not enabled.
	Measures	Execute XClr after resetting the program (canceling the abort status).
L3390	Error message	Cannot use arc pallet
	Cause	Cannot use arc pallet.
	Measures	Change to another method.
L3400	Error message	System error (PROC stack over)
	Cause	System error. (Processor stack overflow)
	Measures	If it comes back, contact your service provider
L3500	Error message	Illegal format input (Input)
	Cause	The type of the variable specified by Input and the type of the received data do not match.
	Measures	Check the format.
L3501	Error message	Illegal Receive data (EBREAD)
	Cause	Type is different (receive data and specified variable)
	Measures	Please confirm specified tag data of the vision.
L3600	Error message	Jump destination does not exist
	Cause	No jump destination was found for the Def Act, On Com and On GoTo commands.
	Measures	Check the jump destination.
L3700	Error message	Undefined variable
	Cause	It was attempted to reference a variable that has not been initialized.
	Measures	Define a variable, enter an initial value, and then use it.
L3710	Error message	Nesting over (CallP)
	Cause	Program Call is used more than the limitation.
	Measures	Reduce the call count of CallP (nesting).
L3720	Error message	RC NX statements unmatched
	Cause	RC NX statements unmatched
	Measures	Match the numbers of RC and NX.
L3750	Error message	Illegal positions (Def Plt)
	Cause	Multi rotation flag (FL2 J1/J4 axis) is different
	Measures	Specify position to become the same multi rotation flag.

Error No.	Error cause and measures	
L3760	Error message	Illegal positions (Def Plt)
	Cause	J1 or J4 axis is greatly changed (Def Plt)
	Measures	Specify positions to be not different greatly
L3810	Error message	Different argument type
	Cause	The type of an argument in an arithmetic operation, monadic operation, comparison operation or each function is different.
	Measures	Designate the correct argument.
L3820	Error message	Undefined intermediate code
	Cause	A program or system status variable may have been damaged.
	Measures	Restore using the backup data. If the backup data is not available, it is necessary to create a program again.
L3830	Error message	Cannot execute GetM
	Cause	GET of the mechanisms is not possible.
	Measures	Check whether the designated mechanisms are being used with a different slot.
L3840	Error message	Return without GoSub
	Cause	Return was executed without using GoSub.
	Measures	Check the program.
L3850	Error message	Undefined PLT
	Cause	The Def Plt command was not executed.
	Measures	Use it after defining a pallet with the Def Plt command.
L3860	Error message	Illegal position data defined
	Cause	There is an error in the position data.
	Measures	Check the position data definition.
L3870	Error message	Illegal mecha No. (****)
	Cause	The designated mecha No. is an invalid value
	Measures	Please set a correct mecha No.
L3880	Error message	Illegal slot No.
	Cause	The task slot number specified in the argument of the system status variables was invalid.
	Measures	Input the correct slot No.
L3890	Error message	System error (make MCODE)
	Cause	An error has occurred when creating an operation instruction. The program may have been damaged.
	Measures	Restore using the backup data. If the backup data is not available, it is necessary to create a program again.
L3900	Error message	JRC Command is disable
	Cause	The JRCEXE parameter is disabled, so it cannot be used.
	Measures	Change the JRCEXE parameter, and then execute.
L3910	Error message	Cannot execute (JRC 0)
	Cause	JRC 0 can not execute for robot arm axis.
	Measures	Correctly set.
L3930	Error message	This command cannot be executed
	Cause	Collision detection is effective
	Measures	Repeal collision detection (execute ColChk Off)
L3940	Error message	ColChk cannot be executed
	Cause	An exclusive function is performing with ColChk
	Measures	Repeal the corresponding function
L3950	Error message	NOERR cannot be executed
	Cause	Interruption using M_ColSts is invalid
	Measures	Define interruption using M_ColSts and confirm it
L3960	Error message	This Act No. cannot be repealed
	Cause	NOERR of collision detection is performed
	Measures	Repeal this interruption after canceling NOERR

Error No.	Error cause and measures	
L3970	Error message	ColChk cannot be performed
	Cause	Collision detection serves as prohibition of use
	Measures	Change parameter COL into use permission
L3980	Error message	Load mode cannot be specified.
	Cause	Prec command is executed
	Measures	Repeal high accuracy mode (execute Prec Off)
L3982	Error message	Cannot be used (singular point)
	Cause 1	This robot does not correspond to the singular point function
	Measures 1	Check the argument of Type specification
	Cause 2	Cmp command is executed
	Measures 2	Invalidate a compliance mode (execute Cmp Off)
	Cause 3	A synchronous addition axis control is effective
	Measures 3	Invalidate a synchronous addition axis control
	Cause 4	Tracking mode is effective
	Measures 4	Invalidate a tracking mode (execute Trk Off)
	Cause 5	Pre-fetch execution is effective
	Measures 5	Invalidate a pre-fetch execution
	Cause 6	This robot is a setting of the multi mechanism
	Measures 6	Do not use the function of passage singular point
	Cause 7	ColChk On command is executed
Measures 7	Invalidate a collision detection (execute ColChk Off)	
H3983	Error message	Cannot execute Cnt movement
	Cause	A structural flag or the angle of the joint is not corresponding
	Measures	It surely positions it by Dly command etc
L3984	Error message	Cannot be passed (singularity)
	Cause	Robot passes position which is very near the singular point
	Measures	Adjust the teaching position
H3985	Error message	Cannot be passed (singularity)
	Cause	Robot passes position which is very near the singular point
	Measures	Adjust the teaching position
L3990	Error message	ColChk cannot be used
	Cause	This robot is a setting of the multi mechanism
	Measures	Change parameter COL into use prohibition
L3991	Error message	Mainte.Forecast cannot be used
	Cause	This robot is a setting of the multi mechanism
	Measures	Invalidate the maintenance forecast
L4000	Error message	System error (time out)
	Cause	There is a problem in the program's exclusive process.
	Measures	If it comes back, contact your service provider.
L4100	Error message	No. of registered file is full
	Cause	The No. of program has been exceeded.
	Measures	Delete any unnecessary programs.
L4110	Error message	Memory area is full
	Cause	The program and data have exceeded the capacity.
	Measures	Delete any unnecessary programs or data.
L4120	Error message	Too long program name
	Cause	The program name is a maximum of 12 characters with 3 extension characters.
	Measures	Set the program name to within 12 characters and 3 extension characters.

Error No.	Error cause and measures	
L4130	Error message	Illegal program name
	Cause	An illegal character was used in the program name.
	Measures	Only numbers and alphabetic characters can be used.
L4140	Error message	The program was not found
	Cause	The designated program was not found.
	Measures	Designate a different program, or create the designated program.
L4150	Error message	Program is faulty
	Cause	Power shutdown may have occurred during the write operation.
	Measures	The file may have been damaged. Delete the file.
L4160	Error message	Not a robot program
	Cause	The designated program is not a robot program.
	Measures	Designate a different program.
L4170	Error message	The program is being edited
	Cause	The program is being edited.
	Measures	Close the program being edited.
L4180	Error message	Program is running
	Cause	The program is running.
	Measures	Stop the program.
L4190	Error message	The program is selected
	Cause	The program is preparing to execute.
	Measures	Reset the program.
L4200	Error message	Cannot write to file
	Cause	Write operation is prohibited, or the file capacity is insufficient.
	Measures	1. Enable file writing. 2. Delete unnecessary files.
L4210	Error message	Too long statement
	Cause	The command statement length is limited to 240 characters.
	Measures	Delete the No. of characters in the command statement to within 240 characters.
L4220	Error message	Syntax error
	Cause	There is an error in the syntax of the input command statement.
	Measures	Re-input in the correct syntax after checking the contents.
L4230	Error message	The line No. does not exist
	Cause	There is no specified line number.
	Measures	Check the contents, and reinput the correct line No.
L4240	Error message	The statement is write protected
	Cause	The command statement is write protected.
	Measures	Cancel the write protection.
L4250	Error message	No more lines or variables
	Cause	Reading of lines and variables exceeding the registered ones.
	Measures	Check the programs.
L4300	Error message	Too long variable name
	Cause	The variable name length is limited to 8 characters.
	Measures	Shorten the variable name to within 8 characters.
L4310	Error message	Illegal character is used
	Cause	A character other than A to Z or 0 to 9 was used.
	Measures	Use the character which can be used.
L4320	Error message	The variable is write protected
	Cause	The variable is write protected.
	Measures	1. Use a writable variable. 2. Cancel the write protection.

Error No.	Error cause and measures	
L4330	Error message	The variable is read protected
	Cause	The variable is read protected.
	Measures	1. Use a writable variable. 2. Cancel the write protection.
L4340	Error message	The variable is not defined
	Cause	The variable has not been defined.
	Measures	Define the variable.
L4350	Error message	Duplicate definition (Val.)
	Cause	Variables already defined cannot be redefined with the Dim or Def statements.
	Measures	1. Change the variable name and define. 2. Delete the defined variable.
L4360	Error message	Same variable used (65535 times)
	Cause	Example: 1 P1=P1+P2 references P1 twice and P2 once.
	Measures	Change the program to reduce the No. of times the same variable is used.
L4370	Error message	Error in the array element
	Cause	1. The array elements exceeds the define range. 2. The specified variable is not an array.
	Measures	1. Correct the number of array elements within one to the maximum elements. 2. Do not specify array elements.
L4380	Error message	Cannot delete variables (used)
	Cause	Variables used in a command statement cannot be deleted.
	Measures	Delete the command statement using the variable.
L4390	Error message	Variable type combination error
	Cause	The type of the user-defined external variable is different.
	Measures	Match the variable types.
L4400	Error message	Program is faulty.
	Cause	The content of the program is abnormal.
	Measures	Delete the program.
L4420	Error message	Line No exceeds 32767
	Cause	The new line No. or line gap is large.
	Measures	Do not use line No. exceeding 32767.
L4430	Error message	Not found the string searched
	Cause	The character string searched for was not found.
	Measures	Check the program.
L4440	Error message	Duplicate definition (label)
	Cause	A label already defined cannot be redefined.
	Measures	1. Change the label name. 2. Delete the defined label line.
L4460	Error message	Argument value range over
	Cause	Argument value range over.
	Measures	Confirm the argument range, and correct the value.
L4470	Error message	Line No can't be used
	Cause	Line No can't be used
	Measures	Please use the label
L4800	Error message	System error (System base prog)
	Cause	The base program for the system could not be opened. Or, the system base program name was not specified correctly in the parameter.
	Measures	If it comes back, contact your service provider.

Error No.	Error cause and measures	
L4810	Error message	The global variable defined by user is not available
	Cause	The parameter "PRGUSR" is not correct.
	Measures	To use user-defined external variables, it is necessary to set the name of the program describing only variable definitions in the PRGUSR parameter.
L4811 *	Error message	The global variable redefined
	Cause	A system global variable is defined in user global.
	Measures	Correct the program.
L4820	Error message	No editing program
	Cause	The program was closed while editing. For example, the program being edited is closed when a key switch enable/disable operation is performed via the T/B during online editing on a PC.
	Measures	Try editing the program again.
L4900	Error message	System error (Prog Hndl)
	Cause	The program name used by internal processing is not normal.
	Measures	If it comes back, contact your service provider.
L4910	Error message	Robot Language is mismatched
	Cause	The parameter RLNG is mismatched. (2:MELFA-BASIC V, 1:MELFA-BASIC IV)
	Measures	Re-set RLNG or select an other program.
L4920	Error message	There is no backup data in ROM
	Cause	There is no backup data in ROM.
	Measures	Please operate after backup.
L4930	Error message	CavChk cannot be executed (*)
	Cause	Collision avoidance serves as prohibition of use
	Measures	Change parameter CAV into use permission
	Error message	CavChk cannot be used
	Cause	This robot does not correspond to collision avoidance
	Measures	Delete CavChk command
L4931	Error message	Cmp command cannot be executed
	Cause	Collision avoidance is effective
	Measures	Repeal collision avoidance (execute CavChk Off)
L4932	Error message	Trk command cannot be executed
	Cause	Collision avoidance is effective
	Measures	Repeal collision avoidance (execute CavChk Off)
L4933	Error message	CavChk cannot be executed
	Cause	Cmp command is executed
	Measures	Repeal compliance mode (execute Cnp Off)
L4934	Error message	CavChk cannot be executed
	Cause	Trk command is executed
	Measures	Repeal tracking mode (execute Trk Off)
L4935	Error message	NOERR cannot be executed
	Cause	Interruption using M_CavSts is invalid
	Measures	Define interruption using M_CavSts and confirm it
L4936	Error message	This ACT No. cannot be repealed
	Cause	NoErr of collision avoidance is performed
	Measures	Repeal this interruption after canceling NoErr
L4937	Error message	A user free area size is lack
	Cause	The size of a user free area is smaller than that of 2K
	Measures	Please set 2K or more to the size of a user free area
L4938	Error message	This robot does not correspond to collision avoidance.
	Cause	This robot does not correspond to collision avoidance.
	Measures	Parameter CAV returns disapproval.

Error No.	Error cause and measures	
L4939	Error message	CAV version of Robot No.n is old
	Cause	Software version of Robot No.n is old
	Measures	Interference avoidance function cannot be used because the software version of interference avoidance of the robot-n is old. Software version upgrade is required. Contact the maker.
H5000	Error message	TB Enable key is ON
	Cause	The [T/B ENABLE" switch is "ENABLE", when the [MODE] switch of the operation panel is "AUTO".
	Measures	Invalidate the T/B Enable key, or enter the teach mode of operation panel.
L5010	Error message	AUTOENA signal is OFF
	Cause	The automatic operation possible signal is OFF.
	Measures	Turn the automatic operation possible signal ON, or enter the teach mode.
L5100	Error message	No program is selected
	Cause	A program is not selected for the designated slot.
	Measures	Select a program for the designated slot.
L5110	Error message	Continuous RUN is not possible
	Cause	A different program name has been designated.
	Measures	Designate the correct program name.
L5120	Error message	Cannot select program (not PSA)
	Cause	The specified slot is not in the program selection state.
	Measures	Reset the program.
L5130	Error message	Cannot execute servo on
	Cause	A servo OFF process is taking place.
	Measures	Wait for the servo to turn OFF before turning the servo ON.
L5140	Error message	Cannot read the file
	Cause	Reading is being carried out, or editing is being carried out.
	Measures	Close the file being edited, or read after the reading is completed.
L5150	Error message	The origin has not been set
	Cause	The origin has not been set.
	Measures	Set the origin.
L5200 *	Error message	Parameter error (TASKMAX)
	Cause	The TASKMAX parameter setting value has been exceeded (initial value: 8, maximum value: 32).
	Measures	Reduce the number of multi tasks, or change the TASKMAX parameter.
L5210 *	Error message	Parameter error (MECHAMAX)
	Cause	The No. of multi mechanisms has exceeded the limit.
	Measures	Reduce the No. of multi mechanisms.
L5400	Error message	All robot cannot be designated
	Cause	All mechanisms cannot be specified.
	Measures	Specify an independent mechanism number.
L5410	Error message	Non-existent mode
	Cause	It has been changed to a mode other than Auto/Teach.
	Measures	Contact the maker.
L5420	Error message	Illegal slot No.
	Cause	A task slot number other than 1 through TASKMAX (parameter) is specified.
	Measures	Designate the correct task slot.
L5430	Error message	Illegal robot No.
	Cause	The mechanism designation is illegal.
	Measures	Designate the correct mechanism.
L5600	Error message	Cannot execute during an error
	Cause	Cannot execute during an error.
	Measures	Reset the error.



Error No.	Error cause and measures	
C5610	Error message	Cannot execute during STOP ON
	Cause	Cannot execute during stop signal input.
	Measures	Turn the stop signal OFF and execute.
L5620	Error message	Cannot execute during CSTOP ON
	Cause	Cannot execute during cycle stop signal input.
	Measures	Turn the cycle stop signal OFF.
L5630	Error message	Cannot execute during SRVOFF ON
	Cause	Cannot execute during servo OFF signal input.
	Measures	Turn the servo OFF signal OFF.
L5640	Error message	Cannot execute during RUN
	Cause	Cannot execute during operation.
	Measures	Stop the operation, and then execute.
L5650	Error message	Cannot execute during STOP
	Cause	Cannot execute during stop operation.
	Measures	Complete the stop, and then execute.
L5660	Error message	Edit during RUN (include ALWAYS)
	Cause	Editing cannot be performed while in operation (including continuous execution).
	Measures	Stop the program, and then execute.
C5670	Error message	Cannot execute during wait
	Cause	Cannot execute during wait
	Measures	Execute Program Reset
L5990	Error message	System error (Illegal command)
	Cause	Not exist command was executed.
	Measures	Execute the correct command.
L6010	Error message	Illegal command
	Cause	This may have occurred because data was sent before the communication line was opened via a data link, or an unregistered communication command was sent due to the mismatch between the versions of the controller and support software.
	Measures	Send after the communication line is opened. Or, match the versions.
L6020	Error message	The Operation is disable
	Cause	The operation rights have not been acquired.
	Measures	Acquire the operation rights.
L6030	Error message	The editing operation is disable
	Cause	The editing operation rights have not been acquired.
	Measures	Acquire the editing operation rights.
L6040	Error message	System error (illegal device No)
	Cause	A non-registered device No. was set.
	Measures	Set a valid device.
C6050	Error message	The file cannot be opened
	Cause	The block file cannot be opened.
	Measures	Check the file, and designate the correct file.
C6060	Error message	The mode is not TEACH
	Cause	Carry out parameter writing in the teach mode.
	Measures	Change to the teaching mode, and then execute.
C6070	Error message	The time cannot be set
	Cause	The time setting can only be executed when the program is stopped and the servo is OFF.
	Measures	Stop the program and turn the servo OFF, and then set the time.
C6080	Error message	Com mesg is too long
	Cause	The character string of a communication text exceeded the maximum number allowed.
	Measures	Verify the number of characters in a comment in various settings such as parameters.

Error No.	Error cause and measures	
C6090	Error message	Can not power reset of robot
	Cause	Can not power reset of robot
	Measures	Can not power reset of robot
C6500	Error message	Not opened COM line
	Cause	Open was not executed by the program.
	Measures	Execute Open, and then send PRN.
H6530 *	Error message	COMDEV parameter is illegal
	Cause	Illegal parameter (COMDEV).
	Measures	Correct COMDEV parameter.
L6600	Error message	Signal number is out of range.
	Cause	The designated signal No. has not been defined.
	Measures	Change the signal No. to the correct No.
L6610	Error message	Cannot output (hand input)
	Cause	The hand input signal cannot be written.
	Measures	Use the correct output signal.
L6620	Error message	Cannot write (special Input)
	Cause	The input signal cannot be written into the robot dedicated area.
	Measures	Use an actual signal.
L6630	Error message	Input signal cannot be written
	Cause	This is the actual signal input mode.
	Measures	Set a pseudo-input signal.
H6640	Error message	Illegal param (special signal)
	Cause	The parameter setting is illegal.
	Measures	Correct the changed parameter.
L6641	Error message	Duplicate setting (special IN)
	Cause	The parameter setting is illegal.
	Measures	Correct the parameter of the dedicated input signal you changed.
H6642 *	Error message	STOP is fixed signal No. 0
	Cause	The parameter setting is illegal.
	Measures	Set the parameter STOP(input) to 0.
H6643	Error message	Illegal parameter (special Sig.)
	Cause	The parameter setting is illegal.
	Measures	Make the ending number larger than the starting number.
L6650 *	Error message	Duplicate setting (special OUT)
	Cause	The parameter setting is illegal.
	Measures	Correct the parameters.
L6651 *	Error message	Duplicate setting (HANDTYPE)
	Cause	The parameter setting is illegal.
	Measures	Correct the parameter.
L6660	Error message	Cannot output (SPECIAL OUT)
	Cause	The program setting is illegal.
	Measures	Correct the program.
L6670	Error message	Illegal OUT reset pattern
	Cause	The parameters are not defined in sets of 8 characters.
	Measures	Correct the parameters.
L6800 *	Error message	"Cancel pseudo-input mode, PW OFF"
	Cause	If pseudo input was canceled, it is necessary to turn the power ON again in order to prevent the erroneous operation of the robot by external input signals.
	Measures	Turn the power OFF and then ON once. It switches to an external input signal.

Error No.	Error cause and measures	
C6900	Error message	Pseudo-input signal mode
	Cause	Set with the parameters.
	Measures	To set a real signal, reset the parameter and then turn the power ON again.
C7000	Error message	Copy source file was not found
	Cause	The copy source file was not found.
	Measures	Input the correct file name.
C7010	Error message	Delete target file was not found
	Cause	The delete target file was not found.
	Measures	Input the correct file name.
C7020	Error message	Rename target file was not found
	Cause	The rename target file was not found.
	Measures	Input the correct file name.
H7030 *	Error message	System error (param size over)
	Cause	The change capacity is too large.
	Measures	Contact the maker.
C7040	Error message	Parameter changes prohibited
	Cause	Changing this parameter is prohibited as it is a dangerous parameter.
	Measures	Contact the maker.
H7050	Error message	File is illegal
	Cause	This file is damaged.
	Measures	Contact to the dealer.
H7060 *	Error message	System error (RAM area full)
	Cause	The capacity has been exceeded.
	Measures	Contact the maker.
C7070	Error message	Memory area is full
	Cause	The program and data have already exceeded the capacity.
	Measures	Delete any unnecessary programs or data.
L7071	Error message	Not enough memory area for CTN
	Cause	Continue function needs more than 100Kbytes memory area.
	Measures	Delete any unnecessary programs.
C7080	Error message	Can not read parameter
	Cause	Non-existent parameter or illegal password.
	Measures	1. Input the correct parameter name. 2. Input the correct password
C7081	Error message	Can not write parameter
	Cause	Non-existent parameter or illegal password.
	Measures	1. Input the correct parameter name. 2. Input the correct password
C7090	Error message	Parameter comment illegal
	Cause	The number of parameter comment characters exceeded the limit.
	Measures	Operation will not be affected, so continue the operation.
L7099	Error message	Can not read parameter "xxx". "xxx": Parameter name.
	Cause	The parameter doesn't exist.
	Measures	Please confirm the parameter name.
H7300 *	Error message	Loading the parameter file.
	Cause	It is necessary to turn the power ON again to reflect the parameters.
	Measures	Turn the power OFF and ON once.

Error No.	Error cause and measures	
C7310	Error message	Changed variables weren't saved
	Cause	The power was OFF during program execution.
	Measures	Don't turn the power OFF during program execution.
L7311	Error message	The power was OFF during file saving
	Cause	The power was OFF during file saving.
	Measures	Don't turn the power OFF during file saving.
L7332	Error message	Can't change to RAM mode in CTN mode
	Cause	Can't change to RAM mode in continue mode.
	Measures	Please change to RAM mode and perform again.
L7340	Error message	Contine function cannot be used in DRAM mode
	Cause	Contine function cannot be used in DRAM mode
	Measures	Please change to RAM mode and perform again
L7341	Error message	Can't change to DRAM mode in CTN mode
	Cause	Can't change to DRAM mode in CTN mode
	Measures	Please change to RAM mode and perform again
L7342	Error message	Global extension cannot be used in DRAM mode
	Cause	Global extension cannot be used in DRAM mode
	Measures	Please change to RAM mode and perform again
L7343	Error message	Can't change to DRAM mode in PRGGBL mode
	Cause	Can't change to DRAM mode in PRGGBL mode
	Measures	Please change to RAM mode and perform again
L7370	Error message	The password is 8 to 32 char.
	Cause	The password is 8 to 32 characters
	Measures	Please input the password 8 to 32 characters
L7371	Error message	Only alphanumeric character
	Cause	It input it excluding the alphanumeric character
	Measures	Please input the password in the alphanumeric character
L7372	Error message	The password is unmatch
	Cause	The password is unmatch
	Measures	Please input the password again
L7373	Error message	Password lock to the programs
	Cause	Password lock to the programs
	Measures	Please release password
L7374	Error message	Password lock to the parameter
	Cause	Password lock to the parameter
	Measures	Please release password
L7375	Error message	Password lock to the files
	Cause	Password lock to the files
	Measures	Please release password
C7410	Error message	1 month inspection is now
	Cause	Carry out the monthly inspection.
	Measures	Carry out the 1 month inspection.
C7420	Error message	3 month inspection is now
	Cause	Carry out the 3 month inspection.
	Measures	Carry out the 3 month inspection.
C7430	Error message	6 month inspection is now
	Cause	Carry out the 6 month inspection.
	Measures	Carry out the 6 month inspection.

Error No.	Error cause and measures	
C7440	Error message	1 year inspection is now
	Cause	Carry out the 1 year inspection.
	Measures	Carry out the 1 year inspection.
C7500	Error message	No battery voltage
	Cause	The battery is spent.
	Measures	Replace the battery of controller and load the data. For more information about the replacement procedure, refer to the separate volumes, "Controller setup, basic operation, and maintenance."
C7510	Error message	Battery voltage low (R/C)
	Cause	The battery will be spent soon.
	Measures	Replace the battery of controller. For more information about the replacement procedure, refer to the separate volumes, "Controller setup, basic operation, and maintenance."
C7520	Error message	Battery consumption time is over
	Cause	The battery consumption time was exceeded
	Measures	Replace the batteries of both the robot arm and controller. For more information about the replacement procedure, refer to the separate volumes, "Instruction Manual/Robot Arm Setup to Maintenance" and "Controller setup, basic operation, and maintenance."
C7530	Error message	Replenishment time of grease
	Cause	It seems that grease reached longevity
	Measures	Replenish grease
C7540	Error message	Exchange time of the belt
	Cause	It seems that the belt reached longevity
	Measures	Execute the check and the exchange of the belt
H7600 *	Error message	Mechanism number of additional axis is illegal.
	Cause	The value of AXMENO (mechanism No. used) parameter is illegal.
	Measures	On the mechanical additional axis, change "0" to a value which is smaller than set to AXUNUM (number of mechanisms used).
H7601 *	Error message	Axis number of additional axis is illegal.
	Cause	The value of AXJNO (setting axis No.) is illegal.
	Measures	Change the value of this parameter from 1 to 3. Change the value of this parameter to a order from 1.
H7602 *	Error message	Axis numbers of additional axis are overlap.
	Cause	As the parameter value of AXJNO (setting axis No.), the same value is set at two or more elements.
	Measures	Change the values of the element Nos. which set the same values at this parameter AXMENO, to all different values.
H7603 *	Error message	Unit of additional axis is illegal.
	Cause	The value of AXUNT (unit axis) parameter is illegal.
	Measures	Change the values of all elements of this parameter to "0" or "1".
H7604 *	Error message	Acceleration time of additional axis is illegal.
	Cause	The value of AXACC (acceleration time) parameter is illegal.
	Measures	Change the values of all elements of this parameter to positive real numbers.
H7605 *	Error message	Deceleration time of additional axis is illegal.
	Cause	The value of AXDEC (deceleration time) parameter is illegal.
	Measures	Change the values of all elements of this parameter to positive real numbers.
H7606 *	Error message	Gear ratio numerator of additional axis is illegal.
	Cause	The value of AXGRTN (total speed ratio numerator) parameter is illegal.
	Measures	Change the values of all elements of this parameter to positive integers.
H7607 *	Error message	Gear ratio denominator of additional axis is illegal.
	Cause	The value of AXGRTD (total speed ratio denominator) parameter is illegal.
	Measures	Change the values of all elements of this parameter to positive integers.

Error No.	Error cause and measures	
H7609 *	Error message	Motor rated speed of additional axis is illegal.
	Cause	The value of AXMREV (rated speed) parameter is illegal.
	Measures	Change the values of all elements of this parameter to positive integers.
H7610 *	Error message	Motor maximum speed of additional axis is illegal.
	Cause	The value of AXJMX (maximum speed) parameter is illegal.
	Measures	Change the values of all elements of this parameter to positive integers.
H7611 *	Error message	Encoder pulse of additional axis is illegal.
	Cause	The value of AXENCRC (encoder resolution) parameter is illegal.
	Measures	Change the values of all elements of this parameter to positive integers.
H7612 *	Error message	JOG smoothening time constant of additional axis is illegal.
	Cause	The value of AXJOGTS (JOG smoothening time constant) parameter is illegal.
	Measures	Change the values of all elements of this parameter to 0 or positive real number.
H7613 *	Error message	Turn OFF the power supply once, and turn ON it again.
	Cause	It is necessary to turn OFF the power supply once.
	Measures	Turn OFF the power supply of the controller, and turn it ON again.
H7700 *	Error message	CC-Link card is illegal (Error Code).
	Cause	CC-Link card is illegal.
	Measures	Please exchange the CC-Link card. When it comes back, contact to the dealer.
H7710 *	Error message	Cannot set a CC-Link master station.
	Cause	A master station is already set by the rotary switch.
	Measures	Set the rotary switch to other than 0.
H7720 *	Error message	Two CC-Link interface cards are mounted.
	Cause	Mount one card in slot 2.
	Measures	It is not allowed to install two cards. Install only one card.
L7730	Error message	CC-Link data link error (local station connection error)
	Cause	There is a line error or the master station's parameter settings are invalid.
	Measures	Review the line and parameters.
L7750	Error message	A (CC-Link) cable is not connected or parameters do not match.
	Cause	A cable is not connected or parameters do not match.
	Measures	Reset the power and start again.
H7760 *	Error message	CC-Link initialization error
	Cause	The master station's parameters do not match.
	Measures	Correct the parameters, and then start again.
L7780	Error message	A CC-Link register number is outside the range.
	Cause	A register number entered is outside the allowable range.
	Measures	Enter the correct value.
L7781	Error message	A signal number for CC-Link was specified.
	Cause	A signal number for CC-Link was specified.
	Measures	Install a CC-Link interface card.
H7810	Error message	Ethernet NETIP parameter ERR (NETIP,NETGW,NETPORT,NETPROC,NETLOGIN,NETPSSWD,NETTOUTR,NETTOUTS,MXTCOM1-3)
	Cause	Parameter settings are incorrect.
	Measures	Correct the parameters.
H7820	Error message	Mxt Scomand timeout
	Cause	The setting time of the MXTTOUT parameter has been exceeded.
	Measures	Make the MXTTOUT parameter value larger.
H7830	Error message	"Ethernet card is not installed, or command disable"
	Cause	Ethernet card is not installed, or command disable.
	Measures	Install Ethernet interface card.

Error No.	Error cause and measures	
H7840	Error message	Mxt command Illegal received data
	Cause	The command argument and the data type do not match.
	Measures	Check the command and the data you are sending.
L8300	Error message	There are a lot of GETPOS define
	Cause	GETPOS function are up to 8.
	Measures	Please use the same Act No. or reset an unnecessary program.
L8310	Error message	GETPOS undefined
	Cause	GETPOS undefined.
	Measures	Please define GETPOS.
H8320	Error message	System Error (GETPOS)
	Cause	Internal data of GETPOS is illegal.
	Measures	Turn the power OFF and ON once.
H8400	Error message	CTN data is illegal (Prec)
	Cause	CTN data is illegal. It changed to Prec Off.
	Measures	Try to set be a Prec mode again.
L8600	Error message	The vision is a unconnection
	Cause	The vision is a unconnection
	Measures	Please check Com No. and Parameter
L8601	Error message	The vision can't be logged on
	Cause	The parameter of the user-name or the password is abnormal
	Measures	Please set the parameter correctly
L8602	Error message	Password is abnormal
	Cause	The password of the user-name is not corresponding
	Measures	Please set the password correctly
L8603	Error message	Parameter is abnormal
	Cause	The parameter of the user-name or the password is abnormal
	Measures	Please set the parameter correctly
L8610	Error message	The communication is abnormal
	Cause	The communication was cut
	Measures	Please check the communications cable
L8620	Error message	The vision number is abnormal
	Cause	The number is not designated by NVOpen
	Measures	Please check NVOpen command
L8621	Error message	Vision program name is abnormal
	Cause	The vision program name has exceeded 15 characters
	Measures	Please make the program name within 15 characters
L8622	Error message	There is no vision program
	Cause	There is no specified vision program
	Measures	Please check the vision program name
L8630	Error message	The recognition cell is illegal
	Cause	There is no value on the cell
	Measures	Please check the recognition cell
L8631	Error message	The cell is outside the range
	Cause	The range of the cell is exceeded
	Measures	Please check the range of the cell
L8632	Error message	The vision is a time-out
	Cause	There is no response from the vision
	Measures	Please check the time-out time

Error No.	Error cause and measures	
L8633	Error message	The vision is a time-out (NVTRG)
	Cause	There is no response from the vision (NVTRG)
	Measures	Please decrease the load of the network
L8634	Error message	There is a comma within the range of the cell
	Cause	There is a comma within the range of the cell
	Measures	Please check the range of the cell
L8635	Error message	There is no comma within the range of the cell
	Cause	There is no comma within the range of the cell
	Measures	Please check the range of the cell
L8636	Error message	Vision Tag name is abnormal
	Cause	There is no specified vision tag in the vision program
	Measures	Please correct the vision tag name
L8640	Error message	The image trigger is abnormal
	Cause	The trigger setting of the vision sensor is abnormal
	Measures	Please check the trigger setting
L8650	Error message	Please make the vision online
	Cause	The vision sensor is off-line
	Measures	Please make vision sensor online
L8660	Error message	There is no authority
	Cause	The authority of the user-name is not a full access
	Measures	Please check user name
L8670	Error message	Can not restart
	Cause	It started without resetting it
	Measures	Please reset the program
L8700 (CR750-Q only)	Error message	Multi CPU system self-check error
	Cause	Illegal parameter of multi CPU system and CPU is abnormal,etc.
	Measures	Confirm details and measures of the error with GX Developer etc.
L8710	Error message	PC I/O module parameter(m) error. (m): Target parameter numbers 1-4. (correspond to QXYUNIT 1-4)
	Cause	An illegal setting of the PC I/O module was detected.
	Measures	Please check the value of parameter.
L8720	Error message	Fuse is blown.(PC I/O module (m)). (m): Target parameter numbers 1-4. (correspond to QXYUNIT 1-4)
	Cause	Fuse is blown.(PC I/O module)
	Measures	Please refer to the manual of PC I/O module.
L8730	Error message	I/O module (m) remove error. (m): Target parameter numbers 1-4. (correspond to QXYUNIT 1-4)
	Cause	PC I/O module was removed.
	Measures	Please mount PC I/O module.



Error No.	Error cause and measures	
H8800 *	Error message	ASIC communication error
	Cause	<p>A failure was detected in the communication within the controller. The internal temperature of the controller may be high. For the CR750-Q/CR751-Q controller, the following conditions may also be the cause.</p> <ul style="list-style-type: none"> <li>• The power on timing may be incorrect.</li> <li>• The cable between the drive unit and the robot CPU may have a fault.</li> </ul>
	Measures	<p>Confirm that the controller filter has no clogging and the ambient temperature is 40 °C or less. If the error persists after taking above measures, contact the manufacturer. For the CR750-Q/CR751-Q controller, turn on the switch of the robot CPU, then of the drive unit. Check the cable connection between the robot CPU and the drive unit.</p>
	Error message	ASIC CRC error
	Cause	<p>A failure was detected in the communication within the controller. The internal temperature of the controller may be high. For the CR750-Q/CR751-Q controller, the following conditions may also be the cause.</p> <ul style="list-style-type: none"> <li>• The power on timing may be incorrect.</li> <li>• The cable between the drive unit and the robot CPU may have a fault.</li> </ul>
	Measures	<p>Confirm that the controller filter has no clogging and the ambient temperature is 40 °C or less. If the error persists after taking above measures, contact the manufacturer. For the CR750-Q/CR751-Q controller, turn on the switch of the robot CPU, then of the drive unit. Check the cable connection between the robot CPU and the drive unit.</p>
	Error message	ASIC short frame error
	Cause	<p>A failure was detected in the communication within the controller. The internal temperature of the controller may be high. For the CR750-Q/CR751-Q controller, the following conditions may also be the cause.</p> <ul style="list-style-type: none"> <li>• The power on timing may be incorrect.</li> <li>• The cable between the drive unit and the robot CPU may have a fault.</li> </ul>
	Measures	<p>Confirm that the controller filter has no clogging and the ambient temperature is 40 °C or less. If the error persists after taking above measures, contact the manufacturer. For the CR750-Q/CR751-Q controller, turn on the switch of the robot CPU, then of the drive unit. Check the cable connection between the robot CPU and the drive unit.</p>
	Error message	ASIC overrunning error
	Cause	<p>A failure was detected in the communication within the controller. The internal temperature of the controller may be high. For the CR750-Q/CR751-Q controller, the following conditions may also be the cause.</p> <ul style="list-style-type: none"> <li>• The power on timing may be incorrect.</li> <li>• The cable between the drive unit and the robot CPU may have a fault.</li> </ul>
	Measures	<p>Confirm that the controller filter has no clogging and the ambient temperature is 40 °C or less. If the error persists after taking above measures, contact the manufacturer. For the CR750-Q/CR751-Q controller, turn on the switch of the robot CPU, then of the drive unit. Check the cable connection between the robot CPU and the drive unit.</p>
	Error message	ASIC connector connection error
	Cause	<p>A failure was detected in the communication within the controller. The internal temperature of the controller may be high. For the CR750-Q/CR751-Q controller, the following conditions may also be the cause.</p> <ul style="list-style-type: none"> <li>• The power on timing may be incorrect.</li> <li>• The cable between the drive unit and the robot CPU may have a fault.</li> </ul>
	Measures	<p>Confirm that the controller filter has no clogging and the ambient temperature is 40 °C or less. If the error persists after taking above measures, contact the manufacturer. For the CR750-Q/CR751-Q controller, turn on the switch of the robot CPU, then of the drive unit. Check the cable connection between the robot CPU and the drive unit.</p>
	Error message	ASIC 0byte transmission
Cause	<p>A failure was detected in the communication within the controller. The internal temperature of the controller may be high. For the CR750-Q/CR751-Q controller, the following conditions may also be the cause.</p> <ul style="list-style-type: none"> <li>• The power on timing may be incorrect.</li> <li>• The cable between the drive unit and the robot CPU may have a fault.</li> </ul>	
Measures	<p>Confirm that the controller filter has no clogging and the ambient temperature is 40 °C or less. If the error persists after taking above measures, contact the manufacturer. For the CR750-Q/CR751-Q controller, turn on the switch of the robot CPU, then of the drive unit. Check the cable connection between the robot CPU and the drive unit.</p>	

Error No.	Error cause and measures	
H8810	Error message	Communication error
	Cause	Error occurred by the data transmission to the servo
	Measures	Check the communication cable connection
	Error message	Illegal ID
	Cause	ID of the com. data with the servo is not corresponding
	Measures	Turn the power OFF and ON once
H8820	Error message	Communication timeout
	Cause	The communication with the servo became a timeout
	Measures	Turn the power OFF and ON once
H8830	Error message	Amplifier unconnection
	Cause	The servo amplifier cannot be detected
	Measures	Check the cable connection and the power supply of amp.
	Error message	Servo axis setting error
	Cause	The axis setting is not correct
	Measures	Check the servo axis settings (parameters, rotary switches)
	Error message	Uncorrespondence amplifier
	Cause	Uncorrespondence amplifier is connected
	Measures	Remove the uncorrespondence amplifier
	Error message	Uncorrespondence protocol
	Cause	The communication protocol which does not correspond
	Measures	Remove the uncorrespondence amplifier
	Error message	Illegal motor ID
	Cause	Uncorrespondence motor is connected
	Measures	Remove the uncorrespondence motor
	Error message	Parameter setting failure
	Cause	A set value of the servo parameter is illegal
	Measures	Change to a correct value
H8870	Error message	Transient processing error
	Cause	Illegal demand data was transmitted
	Measures	Check the demand data
	Error message	Transient processing timeout
	Cause	There is no response to the demand from servo
	Measures	Transmit the demand data again
H9000 ~ H9099	Error message	User High level error
	Cause	A high-level alarm was issued from the robot program.
	Measures	Check the program.
L9100 ~ L9199	Error message	User Low level error
	Cause	A low-level alarm was issued from the robot program.
	Measures	Check the program.
C9200 ~ C9299	Error message	User Caution level error
	Cause	A warning was issued from the robot program.
	Measures	Check the program.

2 Appendix

Appendix 1: Place where fuse replacement is required

(1) Place where fuse (F3) replacement is required.

Removes the top cover of the controller and replaces the fuse (F3) of the printed circuit board (YZ801).

Remove the six top cover fixing screws (M3 x 6), and remove the top cover.

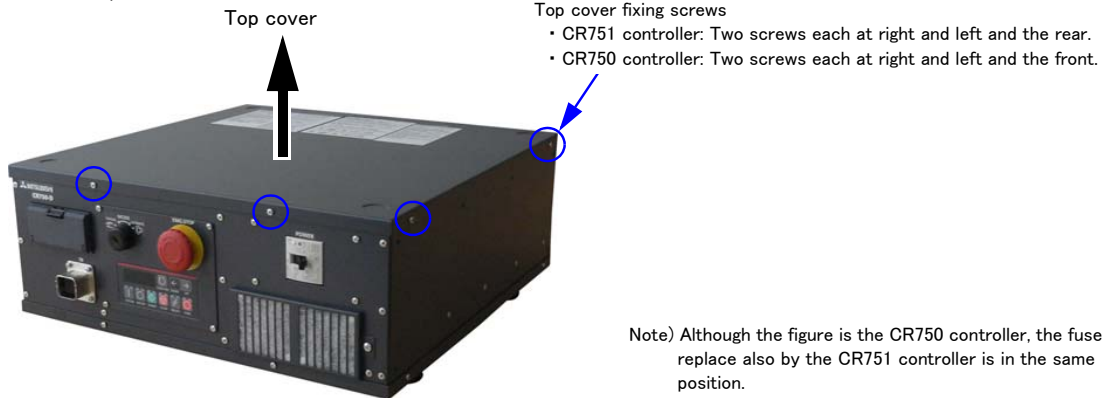

Top view inside the controller

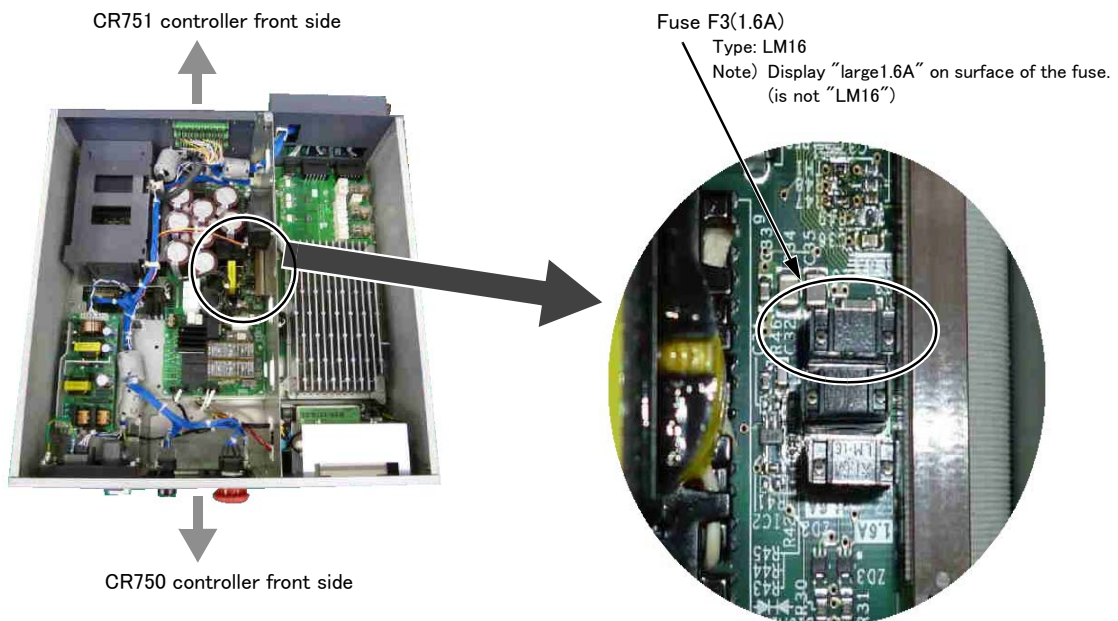
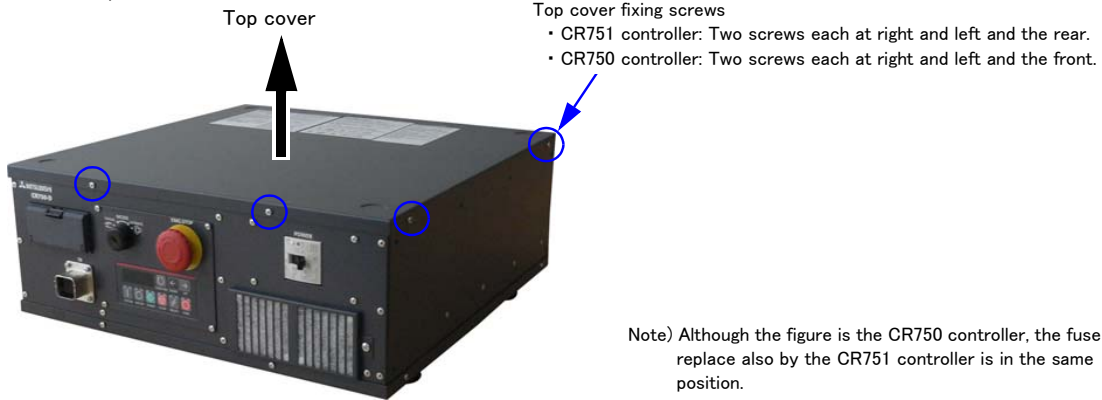

Fig.2-1 : Fuse (F3) exchange place

(2) Place where fuse (F8) replacement is required.

Removes the top cover of the controller and replaces the fuse (F8) of the printed circuit board (YZ311).

Remove the six top cover fixing screws (M3 x 6), and remove the top cover.



Top view inside the controller

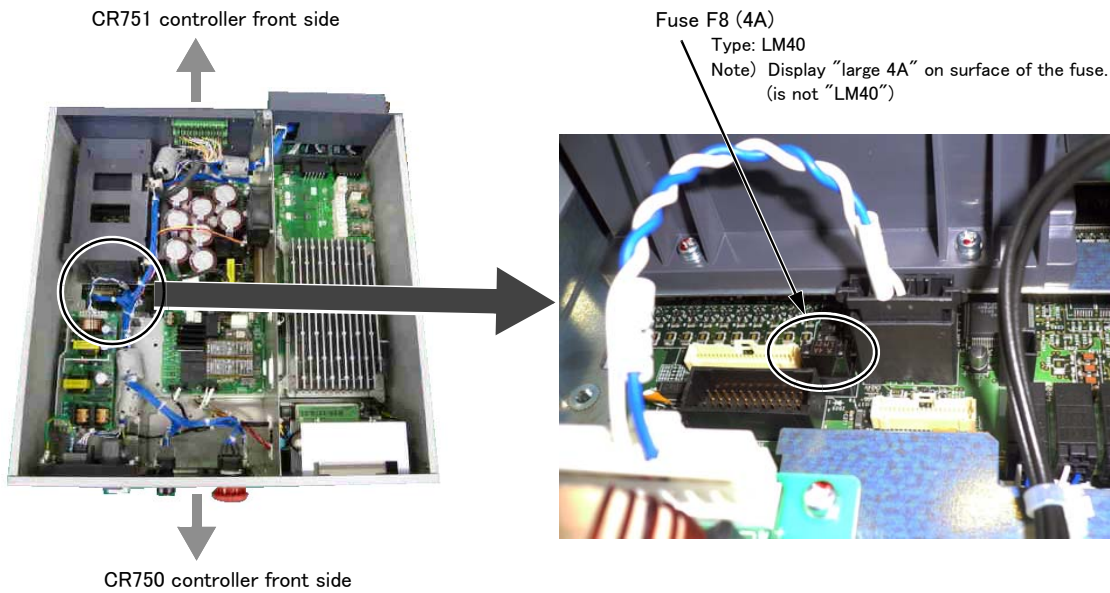

Fig.2-2 : Fuse (F8) exchange place

Appendix 2: Fan installation place of robot controller (drive unit).

The installation place of the fan of the robot controller (drive unit) is shown in the following.

<CR750 controller/drive unit>

Top view

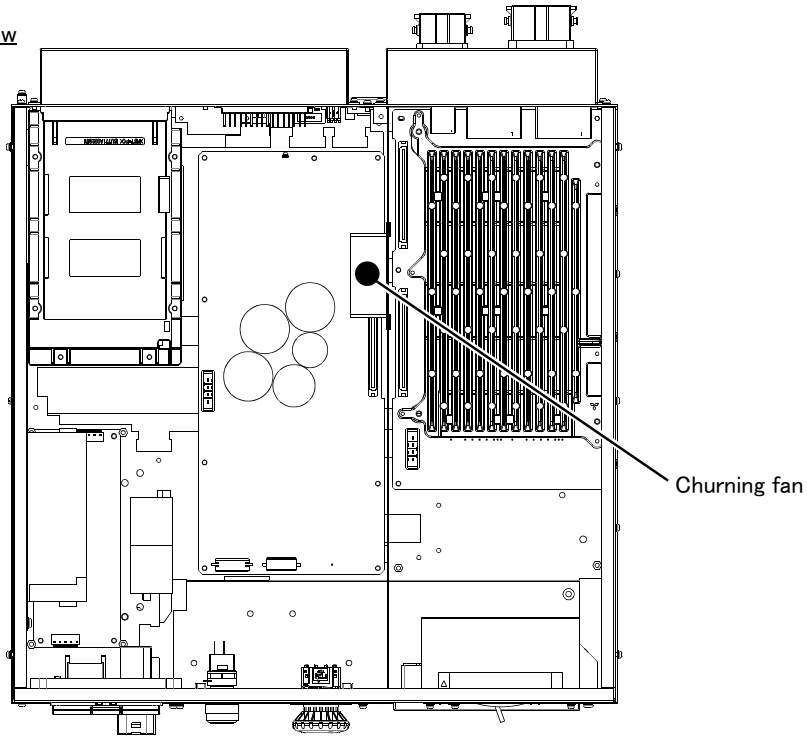

Front view

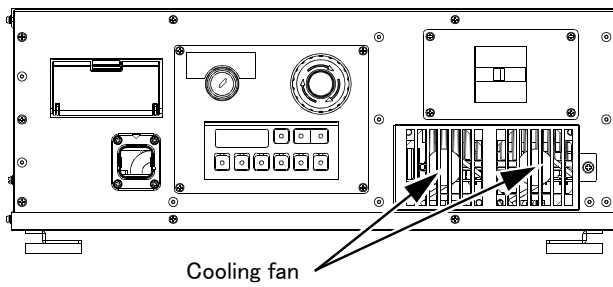

<CR751 controller>

Front view

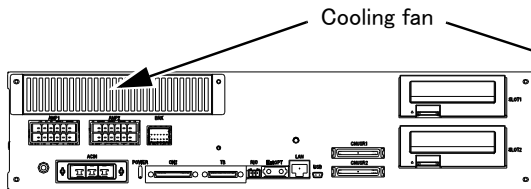

<CR751 Drive unit>

Front view

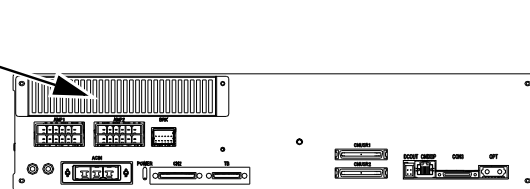

Fig.0-3 : Fan installation place

### Appendix 3: Troubles and measures

No.	Issue			
1	Operation panel does not display anything.			
	<table border="1"> <tr> <td>Cause</td> <td> <ul style="list-style-type: none"> <li>• CPU has not started up properly.</li> <li>• There is no power supply.</li> <li>• An instantaneous power cut exceeding the specification level may have occurred.</li> </ul> </td> </tr> <tr> <td>Measures</td> <td> <ul style="list-style-type: none"> <li>• Check that the primary side's power supply voltage is being supplied properly.</li> <li>• If that the same issue occurs when turning on the power supply, please contact the manufacturer.</li> <li>• If that C1850 error has occurred in the error history, it is possibly due to an instantaneous power cut.</li> </ul> </td> </tr> </table>	Cause	<ul style="list-style-type: none"> <li>• CPU has not started up properly.</li> <li>• There is no power supply.</li> <li>• An instantaneous power cut exceeding the specification level may have occurred.</li> </ul>	Measures
Cause	<ul style="list-style-type: none"> <li>• CPU has not started up properly.</li> <li>• There is no power supply.</li> <li>• An instantaneous power cut exceeding the specification level may have occurred.</li> </ul>			
Measures	<ul style="list-style-type: none"> <li>• Check that the primary side's power supply voltage is being supplied properly.</li> <li>• If that the same issue occurs when turning on the power supply, please contact the manufacturer.</li> <li>• If that C1850 error has occurred in the error history, it is possibly due to an instantaneous power cut.</li> </ul>			
2	When turning on the power supply of the controller, although the FAN of the controller is operating, the operation panel does not light up and the operation of the robot cannot be done, or although the T/B has got the electricity, the operation of T/B cannot be done.			
	<table border="1"> <tr> <td>Cause</td> <td>• AC line inside the controller may have detected the abnormalities.</td> </tr> <tr> <td>Measures</td> <td>• If the same issue occur when turning on the power supply again, please contact to the dealer.</td> </tr> </table>	Cause	• AC line inside the controller may have detected the abnormalities.	Measures
Cause	• AC line inside the controller may have detected the abnormalities.			
Measures	• If the same issue occur when turning on the power supply again, please contact to the dealer.			
3	An unusual noise can be heard (from the robot arm).			
	<table border="1"> <tr> <td>Cause</td> <td> <ul style="list-style-type: none"> <li>• Unusual noises can be caused by friction between movable parts, deformed parts, foreign matters getting inside, and defects in belt tension.</li> <li>• An unusual noise is also made from the fan and the cover bolts became loosened.</li> </ul> </td> </tr> <tr> <td>Measures</td> <td> <ul style="list-style-type: none"> <li>• Identify the particular point from where the unusual noise is being made, and where necessary treat the problem by replacing parts, etc.</li> <li>• When operating at slow speeds, a rattling sound can be heard from the brakes, but this is not unusual. However, if the noise gets louder as the speed gets higher, contact the manufacturer.</li> </ul> </td> </tr> </table>	Cause	<ul style="list-style-type: none"> <li>• Unusual noises can be caused by friction between movable parts, deformed parts, foreign matters getting inside, and defects in belt tension.</li> <li>• An unusual noise is also made from the fan and the cover bolts became loosened.</li> </ul>	Measures
Cause	<ul style="list-style-type: none"> <li>• Unusual noises can be caused by friction between movable parts, deformed parts, foreign matters getting inside, and defects in belt tension.</li> <li>• An unusual noise is also made from the fan and the cover bolts became loosened.</li> </ul>			
Measures	<ul style="list-style-type: none"> <li>• Identify the particular point from where the unusual noise is being made, and where necessary treat the problem by replacing parts, etc.</li> <li>• When operating at slow speeds, a rattling sound can be heard from the brakes, but this is not unusual. However, if the noise gets louder as the speed gets higher, contact the manufacturer.</li> </ul>			
4	An unusual noise can be heard (from RC)			
	<table border="1"> <tr> <td>Cause</td> <td> <ul style="list-style-type: none"> <li>• A noise is made as the internally mounted fan and its casing resonate.</li> <li>• A noise is made by the fan catching internal wiring.</li> </ul> </td> </tr> <tr> <td>Measures</td> <td> <ul style="list-style-type: none"> <li>• Check the state of the cover fastening.</li> <li>• Check to see whether or not the fan is interfering with cables, etc.</li> <li>• If no improvement is made after carrying out the above measures, please contact the manufacturer.</li> </ul> </td> </tr> </table>	Cause	<ul style="list-style-type: none"> <li>• A noise is made as the internally mounted fan and its casing resonate.</li> <li>• A noise is made by the fan catching internal wiring.</li> </ul>	Measures
Cause	<ul style="list-style-type: none"> <li>• A noise is made as the internally mounted fan and its casing resonate.</li> <li>• A noise is made by the fan catching internal wiring.</li> </ul>			
Measures	<ul style="list-style-type: none"> <li>• Check the state of the cover fastening.</li> <li>• Check to see whether or not the fan is interfering with cables, etc.</li> <li>• If no improvement is made after carrying out the above measures, please contact the manufacturer.</li> </ul>			
5	The tip of the robot is vibrating.			
	<table border="1"> <tr> <td>Cause</td> <td> <ul style="list-style-type: none"> <li>• The load conditions exceed the specified values (mass, inertia)</li> <li>• The load condition settings are not suitable (HNDDAT and WRKDAT settings are not consistent with the load)</li> <li>• The tip is being used near a singular point.</li> <li>• Acceleration or deceleration is too sudden.</li> <li>• The installation stand is not rigid enough.</li> <li>• Vibrations from nearby equipment are being felt.</li> </ul> </td> </tr> <tr> <td>Measures</td> <td> <ul style="list-style-type: none"> <li>• Check the load conditions and the parameter settings. Please also try to adjust the acceleration/deceleration time, the speed, and the teaching point where necessary.</li> <li>• Check the condition of the unit's installation (including external vibrations).</li> <li>• If no improvement is made after carrying out the above measures, please contact the manufacturer.</li> </ul> </td> </tr> </table>	Cause	<ul style="list-style-type: none"> <li>• The load conditions exceed the specified values (mass, inertia)</li> <li>• The load condition settings are not suitable (HNDDAT and WRKDAT settings are not consistent with the load)</li> <li>• The tip is being used near a singular point.</li> <li>• Acceleration or deceleration is too sudden.</li> <li>• The installation stand is not rigid enough.</li> <li>• Vibrations from nearby equipment are being felt.</li> </ul>	Measures
Cause	<ul style="list-style-type: none"> <li>• The load conditions exceed the specified values (mass, inertia)</li> <li>• The load condition settings are not suitable (HNDDAT and WRKDAT settings are not consistent with the load)</li> <li>• The tip is being used near a singular point.</li> <li>• Acceleration or deceleration is too sudden.</li> <li>• The installation stand is not rigid enough.</li> <li>• Vibrations from nearby equipment are being felt.</li> </ul>			
Measures	<ul style="list-style-type: none"> <li>• Check the load conditions and the parameter settings. Please also try to adjust the acceleration/deceleration time, the speed, and the teaching point where necessary.</li> <li>• Check the condition of the unit's installation (including external vibrations).</li> <li>• If no improvement is made after carrying out the above measures, please contact the manufacturer.</li> </ul>			
6	The servo-on cannot be performed			
	<table border="1"> <tr> <td>Cause</td> <td> <ul style="list-style-type: none"> <li>• A servo OFF signal (SRV OFF) is being input from an external source.</li> <li>• The operating right is not given. (IOENA parameters settings/exclusive input and output).</li> <li>• An error is occurring.</li> <li>• TB operation error (enabling switch, activate/deactivate)</li> </ul> </td> </tr> <tr> <td>Measures</td> <td> <ul style="list-style-type: none"> <li>• Check for a servo OFF signal and check the operation rights.</li> <li>• Check how to operate the TB. Check that the 3 position enabling switch is set to the middle position.</li> <li>• If an error message is occurring please cancel it.</li> <li>• If no improvement is made after carrying out the above measures, please contact the manufacturer.</li> </ul> </td> </tr> </table>	Cause	<ul style="list-style-type: none"> <li>• A servo OFF signal (SRV OFF) is being input from an external source.</li> <li>• The operating right is not given. (IOENA parameters settings/exclusive input and output).</li> <li>• An error is occurring.</li> <li>• TB operation error (enabling switch, activate/deactivate)</li> </ul>	Measures
Cause	<ul style="list-style-type: none"> <li>• A servo OFF signal (SRV OFF) is being input from an external source.</li> <li>• The operating right is not given. (IOENA parameters settings/exclusive input and output).</li> <li>• An error is occurring.</li> <li>• TB operation error (enabling switch, activate/deactivate)</li> </ul>			
Measures	<ul style="list-style-type: none"> <li>• Check for a servo OFF signal and check the operation rights.</li> <li>• Check how to operate the TB. Check that the 3 position enabling switch is set to the middle position.</li> <li>• If an error message is occurring please cancel it.</li> <li>• If no improvement is made after carrying out the above measures, please contact the manufacturer.</li> </ul>			

No.	Issue				
7	<p>In automatic drive mode the system does not start up even if a startup signal is input. The robot stops during automatic drive.</p> <table border="1" data-bbox="341 325 1396 619"> <tr> <td data-bbox="341 325 438 483">Cause</td> <td data-bbox="438 325 1396 483"> <ul style="list-style-type: none"> <li>• A stop signal (STOP/STOP2/SKIP) is being input from an external source.</li> <li>• The operating right is not given. (IOENA parameters settings/exclusive input and output).</li> <li>• An error is occurring.</li> <li>• A start signal (START) has not been input.</li> <li>• The slot attribute settings are not set to START.</li> <li>• The program's operation commands have not been executed.</li> </ul> </td> </tr> <tr> <td data-bbox="341 483 438 619">Measures</td> <td data-bbox="438 483 1396 619"> <ul style="list-style-type: none"> <li>• Check for a stop/startup signals and check the operation rights.</li> <li>• Check the attributes of the program.</li> <li>• With the robot stopped, check the status of the operation program's execution.</li> <li>• If an error message is occurring please cancel it.</li> </ul> <p>In no improvement is made after carrying out the above measures, please contact the manufacturer.</p> </td> </tr> </table>	Cause	<ul style="list-style-type: none"> <li>• A stop signal (STOP/STOP2/SKIP) is being input from an external source.</li> <li>• The operating right is not given. (IOENA parameters settings/exclusive input and output).</li> <li>• An error is occurring.</li> <li>• A start signal (START) has not been input.</li> <li>• The slot attribute settings are not set to START.</li> <li>• The program's operation commands have not been executed.</li> </ul>	Measures	<ul style="list-style-type: none"> <li>• Check for a stop/startup signals and check the operation rights.</li> <li>• Check the attributes of the program.</li> <li>• With the robot stopped, check the status of the operation program's execution.</li> <li>• If an error message is occurring please cancel it.</li> </ul> <p>In no improvement is made after carrying out the above measures, please contact the manufacturer.</p>
Cause	<ul style="list-style-type: none"> <li>• A stop signal (STOP/STOP2/SKIP) is being input from an external source.</li> <li>• The operating right is not given. (IOENA parameters settings/exclusive input and output).</li> <li>• An error is occurring.</li> <li>• A start signal (START) has not been input.</li> <li>• The slot attribute settings are not set to START.</li> <li>• The program's operation commands have not been executed.</li> </ul>				
Measures	<ul style="list-style-type: none"> <li>• Check for a stop/startup signals and check the operation rights.</li> <li>• Check the attributes of the program.</li> <li>• With the robot stopped, check the status of the operation program's execution.</li> <li>• If an error message is occurring please cancel it.</li> </ul> <p>In no improvement is made after carrying out the above measures, please contact the manufacturer.</p>				
8	<p>The position becomes offset during automatic drive. The position becomes offset after moving the equipment.</p> <table border="1" data-bbox="341 682 1396 1102"> <tr> <td data-bbox="341 682 438 913">Cause</td> <td data-bbox="438 682 1396 913"> <ul style="list-style-type: none"> <li>• Program error (arithmetic processing, etc.).</li> <li>• Teaching operation error.</li> <li>• Peripheral equipment is offset.</li> <li>• There is a setting error in the origin position data.</li> <li>• The origin position data has been lost (battery life, etc.).</li> <li>• Origin positions are offset (the arm was moved while the power supply was OFF, etc.).</li> <li>• Connecting parts have come loose.</li> <li>• Belt teeth have been skipped.</li> <li>• Increased backlash from the reduction gear.</li> </ul> </td> </tr> <tr> <td data-bbox="341 913 438 1102">Measures</td> <td data-bbox="438 913 1396 1102"> <ul style="list-style-type: none"> <li>• Check the positioning data in the area where the positioning has become offset.</li> <li>• Check the peripheral equipment and the robot's connecting parts (hand, robot installation section, etc.)</li> <li>• Check the remaining time on the robot battery's life.</li> <li>• Check the position of the origin positions.</li> <li>• Check the condition of the belt.</li> <li>• Check whether there is any nearby interference, etc.</li> </ul> <p>If no improvement is made after carrying out the above measures, please contact the manufacturer.</p> </td> </tr> </table>	Cause	<ul style="list-style-type: none"> <li>• Program error (arithmetic processing, etc.).</li> <li>• Teaching operation error.</li> <li>• Peripheral equipment is offset.</li> <li>• There is a setting error in the origin position data.</li> <li>• The origin position data has been lost (battery life, etc.).</li> <li>• Origin positions are offset (the arm was moved while the power supply was OFF, etc.).</li> <li>• Connecting parts have come loose.</li> <li>• Belt teeth have been skipped.</li> <li>• Increased backlash from the reduction gear.</li> </ul>	Measures	<ul style="list-style-type: none"> <li>• Check the positioning data in the area where the positioning has become offset.</li> <li>• Check the peripheral equipment and the robot's connecting parts (hand, robot installation section, etc.)</li> <li>• Check the remaining time on the robot battery's life.</li> <li>• Check the position of the origin positions.</li> <li>• Check the condition of the belt.</li> <li>• Check whether there is any nearby interference, etc.</li> </ul> <p>If no improvement is made after carrying out the above measures, please contact the manufacturer.</p>
Cause	<ul style="list-style-type: none"> <li>• Program error (arithmetic processing, etc.).</li> <li>• Teaching operation error.</li> <li>• Peripheral equipment is offset.</li> <li>• There is a setting error in the origin position data.</li> <li>• The origin position data has been lost (battery life, etc.).</li> <li>• Origin positions are offset (the arm was moved while the power supply was OFF, etc.).</li> <li>• Connecting parts have come loose.</li> <li>• Belt teeth have been skipped.</li> <li>• Increased backlash from the reduction gear.</li> </ul>				
Measures	<ul style="list-style-type: none"> <li>• Check the positioning data in the area where the positioning has become offset.</li> <li>• Check the peripheral equipment and the robot's connecting parts (hand, robot installation section, etc.)</li> <li>• Check the remaining time on the robot battery's life.</li> <li>• Check the position of the origin positions.</li> <li>• Check the condition of the belt.</li> <li>• Check whether there is any nearby interference, etc.</li> </ul> <p>If no improvement is made after carrying out the above measures, please contact the manufacturer.</p>				
9	<p>The leakage current breaker trips when the controller's primary power switch is turned ON. The leakage current breaker trips when the servo is switched on.</p> <table border="1" data-bbox="341 1165 1396 1354"> <tr> <td data-bbox="341 1165 438 1249">Cause</td> <td data-bbox="438 1165 1396 1249"> <ul style="list-style-type: none"> <li>• Incorrect breaker selection (current capacity/drive purpose, etc.).</li> <li>• Leakage current due to electrically conductive foreign matters (oil/moisture) getting inside.</li> <li>• Earthing due to cable wear.</li> </ul> </td> </tr> <tr> <td data-bbox="341 1249 438 1354">Measures</td> <td data-bbox="438 1249 1396 1354"> <ul style="list-style-type: none"> <li>• Check the specification of the breaker.</li> <li>• Check whether or not electrically conductive foreign matters have got inside the robot's body or inside the controller.</li> <li>• Check whether or not the cable is damaged.</li> </ul> </td> </tr> </table>	Cause	<ul style="list-style-type: none"> <li>• Incorrect breaker selection (current capacity/drive purpose, etc.).</li> <li>• Leakage current due to electrically conductive foreign matters (oil/moisture) getting inside.</li> <li>• Earthing due to cable wear.</li> </ul>	Measures	<ul style="list-style-type: none"> <li>• Check the specification of the breaker.</li> <li>• Check whether or not electrically conductive foreign matters have got inside the robot's body or inside the controller.</li> <li>• Check whether or not the cable is damaged.</li> </ul>
Cause	<ul style="list-style-type: none"> <li>• Incorrect breaker selection (current capacity/drive purpose, etc.).</li> <li>• Leakage current due to electrically conductive foreign matters (oil/moisture) getting inside.</li> <li>• Earthing due to cable wear.</li> </ul>				
Measures	<ul style="list-style-type: none"> <li>• Check the specification of the breaker.</li> <li>• Check whether or not electrically conductive foreign matters have got inside the robot's body or inside the controller.</li> <li>• Check whether or not the cable is damaged.</li> </ul>				
10	<p>Oil is leaking from the robot's body</p> <table border="1" data-bbox="341 1396 1396 1627"> <tr> <td data-bbox="341 1396 438 1533">Cause</td> <td data-bbox="438 1396 1396 1533"> <ul style="list-style-type: none"> <li>• Deterioration in the reducer oil seal.</li> <li>• Too much grease was applied.</li> <li>• A grease other than the specified grease was applied.</li> <li>• Excess grease left on the unit when grease was applied.</li> <li>• Foreign materials have stuck to the oil seal (dust, etc.).</li> </ul> </td> </tr> <tr> <td data-bbox="341 1533 438 1627">Measures</td> <td data-bbox="438 1533 1396 1627"> <ul style="list-style-type: none"> <li>• Check the amount of grease that should be applied and the name and product number of the grease.</li> <li>• Take measures to make sure that dust, etc. does not adhere to joints.</li> <li>• After applying grease wipe off any grease that is protruding.</li> </ul> </td> </tr> </table>	Cause	<ul style="list-style-type: none"> <li>• Deterioration in the reducer oil seal.</li> <li>• Too much grease was applied.</li> <li>• A grease other than the specified grease was applied.</li> <li>• Excess grease left on the unit when grease was applied.</li> <li>• Foreign materials have stuck to the oil seal (dust, etc.).</li> </ul>	Measures	<ul style="list-style-type: none"> <li>• Check the amount of grease that should be applied and the name and product number of the grease.</li> <li>• Take measures to make sure that dust, etc. does not adhere to joints.</li> <li>• After applying grease wipe off any grease that is protruding.</li> </ul>
Cause	<ul style="list-style-type: none"> <li>• Deterioration in the reducer oil seal.</li> <li>• Too much grease was applied.</li> <li>• A grease other than the specified grease was applied.</li> <li>• Excess grease left on the unit when grease was applied.</li> <li>• Foreign materials have stuck to the oil seal (dust, etc.).</li> </ul>				
Measures	<ul style="list-style-type: none"> <li>• Check the amount of grease that should be applied and the name and product number of the grease.</li> <li>• Take measures to make sure that dust, etc. does not adhere to joints.</li> <li>• After applying grease wipe off any grease that is protruding.</li> </ul>				
11	<p>Breaker trips/overcurrent error occurs (cutting oil gets inside the robot body)</p> <table border="1" data-bbox="341 1690 1396 1925"> <tr> <td data-bbox="341 1690 438 1795">Cause</td> <td data-bbox="438 1690 1396 1795"> <ul style="list-style-type: none"> <li>• Deterioration in the packing.</li> <li>• Scaling on the packing.</li> <li>• Using a highly permeable cutting oil.</li> <li>• An environment that exceeds the IP functionality.</li> </ul> </td> </tr> <tr> <td data-bbox="341 1795 438 1925">Measures</td> <td data-bbox="438 1795 1396 1925"> <ul style="list-style-type: none"> <li>• In a mist environment, pull off and replace the packing every time the cover is removed.</li> <li>• If a highly permeable cutting fluid is being used, or in an environment that exceeds the IP functionality, purge the air and take measures on the jacket.</li> </ul> <p>* Cutting oil that has got inside the arm must be thoroughly cleaned away or the components inside the arm are at risk of rotting.</p> </td> </tr> </table>	Cause	<ul style="list-style-type: none"> <li>• Deterioration in the packing.</li> <li>• Scaling on the packing.</li> <li>• Using a highly permeable cutting oil.</li> <li>• An environment that exceeds the IP functionality.</li> </ul>	Measures	<ul style="list-style-type: none"> <li>• In a mist environment, pull off and replace the packing every time the cover is removed.</li> <li>• If a highly permeable cutting fluid is being used, or in an environment that exceeds the IP functionality, purge the air and take measures on the jacket.</li> </ul> <p>* Cutting oil that has got inside the arm must be thoroughly cleaned away or the components inside the arm are at risk of rotting.</p>
Cause	<ul style="list-style-type: none"> <li>• Deterioration in the packing.</li> <li>• Scaling on the packing.</li> <li>• Using a highly permeable cutting oil.</li> <li>• An environment that exceeds the IP functionality.</li> </ul>				
Measures	<ul style="list-style-type: none"> <li>• In a mist environment, pull off and replace the packing every time the cover is removed.</li> <li>• If a highly permeable cutting fluid is being used, or in an environment that exceeds the IP functionality, purge the air and take measures on the jacket.</li> </ul> <p>* Cutting oil that has got inside the arm must be thoroughly cleaned away or the components inside the arm are at risk of rotting.</p>				

No.	Issue			
12	The hand does not move properly (air hand)			
	<table border="1"> <tr> <td data-bbox="342 302 435 533">Cause</td> <td data-bbox="435 302 1396 533"> <ul style="list-style-type: none"> <li>• An air leak/break in the piping.</li> <li>• The solenoid bulb has failed.</li> <li>• Wire breakage on the hand signal line.</li> <li>• The hand IF card has failed or has been inserted incorrectly.</li> <li>• Sink/source setting error.</li> <li>• Hand connecting wire error</li> <li>• Insufficient air pressure.</li> <li>• A foreign material has got stuck in the air hose.</li> <li>• Faulty connection in the cables that run between devices.</li> </ul> </td> </tr> <tr> <td data-bbox="342 533 435 667">Measures</td> <td data-bbox="435 533 1396 667"> <ul style="list-style-type: none"> <li>• Carry out a check on the air hose, joints, air pressure, and connecting wire.</li> <li>• Check the condition of the hand input/output signal.</li> <li>• Check whether or not the controller's sink/source settings and wiring are consistent with each other.</li> <li>• Check the condition of the connections on the cables that run between devices.</li> </ul> <p>In the event that no improvement is made after carrying out the above measures, please contact the manufacturer.</p> </td> </tr> </table>	Cause	<ul style="list-style-type: none"> <li>• An air leak/break in the piping.</li> <li>• The solenoid bulb has failed.</li> <li>• Wire breakage on the hand signal line.</li> <li>• The hand IF card has failed or has been inserted incorrectly.</li> <li>• Sink/source setting error.</li> <li>• Hand connecting wire error</li> <li>• Insufficient air pressure.</li> <li>• A foreign material has got stuck in the air hose.</li> <li>• Faulty connection in the cables that run between devices.</li> </ul>	Measures
Cause	<ul style="list-style-type: none"> <li>• An air leak/break in the piping.</li> <li>• The solenoid bulb has failed.</li> <li>• Wire breakage on the hand signal line.</li> <li>• The hand IF card has failed or has been inserted incorrectly.</li> <li>• Sink/source setting error.</li> <li>• Hand connecting wire error</li> <li>• Insufficient air pressure.</li> <li>• A foreign material has got stuck in the air hose.</li> <li>• Faulty connection in the cables that run between devices.</li> </ul>			
Measures	<ul style="list-style-type: none"> <li>• Carry out a check on the air hose, joints, air pressure, and connecting wire.</li> <li>• Check the condition of the hand input/output signal.</li> <li>• Check whether or not the controller's sink/source settings and wiring are consistent with each other.</li> <li>• Check the condition of the connections on the cables that run between devices.</li> </ul> <p>In the event that no improvement is made after carrying out the above measures, please contact the manufacturer.</p>			
13	The hand does not move properly The hand operation screen is not displayed on the TB (Electric operated hand)			
	<table border="1"> <tr> <td data-bbox="342 758 435 915">Cause</td> <td data-bbox="435 758 1396 915"> <ul style="list-style-type: none"> <li>• Wire breakage on the hand signal line.</li> <li>• The electronic hand controller (manufactured by TAIYO Ltd.) has failed.</li> <li>• Faulty connection in the cables that run between devices.</li> <li>• The software version on the TB and robot controller is not compatible with the electric operated hand.</li> <li>• The user is trying to use the electric operated hand on a model that is not compatible with the electric operated hand.</li> </ul> </td> </tr> <tr> <td data-bbox="342 915 435 1075">Measures</td> <td data-bbox="435 915 1396 1075"> <ul style="list-style-type: none"> <li>• Check the connections.</li> <li>• Check the condition of the hand input/output signal.</li> <li>• Check the mating condition of the cables that run between devices.</li> <li>• Check whether the software version is compatible or not.</li> <li>• Check the model compatibility.</li> </ul> <p>If no improvement is made after carrying out the above measures, please contact the manufacturer.</p> </td> </tr> </table>	Cause	<ul style="list-style-type: none"> <li>• Wire breakage on the hand signal line.</li> <li>• The electronic hand controller (manufactured by TAIYO Ltd.) has failed.</li> <li>• Faulty connection in the cables that run between devices.</li> <li>• The software version on the TB and robot controller is not compatible with the electric operated hand.</li> <li>• The user is trying to use the electric operated hand on a model that is not compatible with the electric operated hand.</li> </ul>	Measures
Cause	<ul style="list-style-type: none"> <li>• Wire breakage on the hand signal line.</li> <li>• The electronic hand controller (manufactured by TAIYO Ltd.) has failed.</li> <li>• Faulty connection in the cables that run between devices.</li> <li>• The software version on the TB and robot controller is not compatible with the electric operated hand.</li> <li>• The user is trying to use the electric operated hand on a model that is not compatible with the electric operated hand.</li> </ul>			
Measures	<ul style="list-style-type: none"> <li>• Check the connections.</li> <li>• Check the condition of the hand input/output signal.</li> <li>• Check the mating condition of the cables that run between devices.</li> <li>• Check whether the software version is compatible or not.</li> <li>• Check the model compatibility.</li> </ul> <p>If no improvement is made after carrying out the above measures, please contact the manufacturer.</p>			
14	The hand does not move properly The hand operation screen is not displayed on the TB (Multi hand)			
	<table border="1"> <tr> <td data-bbox="342 1165 435 1417">Cause</td> <td data-bbox="435 1165 1396 1417"> <ul style="list-style-type: none"> <li>• An air leak/break in the piping.</li> <li>• The solenoid valve has failed.</li> <li>• Wire breakage on the hand signal line.</li> <li>• The multi hand dedicated circuit has failed.</li> <li>• Insufficient air pressure.</li> <li>• A foreign material has got stuck in the air hose.</li> <li>• Faulty connection in the cables that run between devices.</li> <li>• Wire breakage on the hand signal line.</li> <li>• The software version on the TB and robot controller is not compatible with the multi hand.</li> <li>• The user is trying to use the multi hand on a model that is not compatible with the multi hand.</li> </ul> </td> </tr> <tr> <td data-bbox="342 1417 435 1602">Measures</td> <td data-bbox="435 1417 1396 1602"> <ul style="list-style-type: none"> <li>• A check on the air hose, joints, air pressure, and connections.</li> <li>• Check the condition of the hand input/output signal.</li> <li>• Check the connections.</li> <li>• Check the mating condition of the cables that run between devices.</li> <li>• Check whether the software version is compatible or not.</li> <li>• Check the model compatibility.</li> </ul> <p>If no improvement is made after carrying out the above measures, please contact the manufacturer.</p> </td> </tr> </table>	Cause	<ul style="list-style-type: none"> <li>• An air leak/break in the piping.</li> <li>• The solenoid valve has failed.</li> <li>• Wire breakage on the hand signal line.</li> <li>• The multi hand dedicated circuit has failed.</li> <li>• Insufficient air pressure.</li> <li>• A foreign material has got stuck in the air hose.</li> <li>• Faulty connection in the cables that run between devices.</li> <li>• Wire breakage on the hand signal line.</li> <li>• The software version on the TB and robot controller is not compatible with the multi hand.</li> <li>• The user is trying to use the multi hand on a model that is not compatible with the multi hand.</li> </ul>	Measures
Cause	<ul style="list-style-type: none"> <li>• An air leak/break in the piping.</li> <li>• The solenoid valve has failed.</li> <li>• Wire breakage on the hand signal line.</li> <li>• The multi hand dedicated circuit has failed.</li> <li>• Insufficient air pressure.</li> <li>• A foreign material has got stuck in the air hose.</li> <li>• Faulty connection in the cables that run between devices.</li> <li>• Wire breakage on the hand signal line.</li> <li>• The software version on the TB and robot controller is not compatible with the multi hand.</li> <li>• The user is trying to use the multi hand on a model that is not compatible with the multi hand.</li> </ul>			
Measures	<ul style="list-style-type: none"> <li>• A check on the air hose, joints, air pressure, and connections.</li> <li>• Check the condition of the hand input/output signal.</li> <li>• Check the connections.</li> <li>• Check the mating condition of the cables that run between devices.</li> <li>• Check whether the software version is compatible or not.</li> <li>• Check the model compatibility.</li> </ul> <p>If no improvement is made after carrying out the above measures, please contact the manufacturer.</p>			



No.	Issue			
15	Brake is not working properly			
	<table border="1"> <tr> <td>Cause</td> <td>           [Occurs only when operating manually]           <ul style="list-style-type: none"> <li>• T/B operation error.</li> <li>• The enabling device input is open.</li> </ul>           [Occurs when operating manually and automatically]           <ul style="list-style-type: none"> <li>• Faulty connection of the cables that run between devices.</li> <li>• Brake failure.</li> </ul> </td> </tr> <tr> <td>Measures</td> <td>           [Occurs only when operating manually]           <ul style="list-style-type: none"> <li>• Check the T/B operation (operation buttons, 3 position enabling switch, etc.).</li> <li>• Short circuit the CNUSR connector's enabling device input.</li> </ul>           [Occurs when operating manually and automatically]           <ul style="list-style-type: none"> <li>• Check the mating of the cables that run between devices.</li> </ul>           If no improvement is made after carrying out the above measures, please contact the manufacturer.         </td> </tr> </table>	Cause	[Occurs only when operating manually] <ul style="list-style-type: none"> <li>• T/B operation error.</li> <li>• The enabling device input is open.</li> </ul> [Occurs when operating manually and automatically] <ul style="list-style-type: none"> <li>• Faulty connection of the cables that run between devices.</li> <li>• Brake failure.</li> </ul>	Measures
Cause	[Occurs only when operating manually] <ul style="list-style-type: none"> <li>• T/B operation error.</li> <li>• The enabling device input is open.</li> </ul> [Occurs when operating manually and automatically] <ul style="list-style-type: none"> <li>• Faulty connection of the cables that run between devices.</li> <li>• Brake failure.</li> </ul>			
Measures	[Occurs only when operating manually] <ul style="list-style-type: none"> <li>• Check the T/B operation (operation buttons, 3 position enabling switch, etc.).</li> <li>• Short circuit the CNUSR connector's enabling device input.</li> </ul> [Occurs when operating manually and automatically] <ul style="list-style-type: none"> <li>• Check the mating of the cables that run between devices.</li> </ul> If no improvement is made after carrying out the above measures, please contact the manufacturer.			
16	The communication fault occurs by the equipment connected to the Ethernet cable inside the robot arm.			
	<table border="1"> <tr> <td>Cause</td> <td> <ul style="list-style-type: none"> <li>• The Ethernet cable is not connected surely.</li> <li>• There are the device etc. which cause the noise and the noise has applied to the Ethernet cable.</li> </ul> </td> </tr> <tr> <td>Measures</td> <td> <ul style="list-style-type: none"> <li>• Confirm that the Ethernet cable is connected surely.</li> <li>• If the effect by the noise can be considered, find out the noise source and remove the noise. Moreover, adds the grounding and ferrite core of the Ethernet cable if needed. Recommendation ferrite core: E04SR301334 (SEIWA ELECTRIC MFG. Co.,Ltd.)</li> </ul> </td> </tr> </table>	Cause	<ul style="list-style-type: none"> <li>• The Ethernet cable is not connected surely.</li> <li>• There are the device etc. which cause the noise and the noise has applied to the Ethernet cable.</li> </ul>	Measures
Cause	<ul style="list-style-type: none"> <li>• The Ethernet cable is not connected surely.</li> <li>• There are the device etc. which cause the noise and the noise has applied to the Ethernet cable.</li> </ul>			
Measures	<ul style="list-style-type: none"> <li>• Confirm that the Ethernet cable is connected surely.</li> <li>• If the effect by the noise can be considered, find out the noise source and remove the noise. Moreover, adds the grounding and ferrite core of the Ethernet cable if needed. Recommendation ferrite core: E04SR301334 (SEIWA ELECTRIC MFG. Co.,Ltd.)</li> </ul>			
17	The T/B does not display anything.			
	<table border="1"> <tr> <td>Cause</td> <td> <ul style="list-style-type: none"> <li>• The fuse (4A fuse) installed at the bottom of the 24 V power supply circuit in the controller may have blown out. For the fuse blowout, the emergency stop made by the customer may be the cause, or there may be a ground fault or short circuit with the 24 V power supply in the wiring of a door switch, enabling device, etc.</li> <li>• The T/B might be out of order.</li> </ul> </td> </tr> <tr> <td>Measures</td> <td> <ul style="list-style-type: none"> <li>• Investigate and correct the ground fault or short circuit portion in the wiring made by the customer. Then, replace the fuse inside the controller. Refer to <a href="#">Page 44, "Fig.2-2 : Fuse (F8) exchange place"</a> for details. (On details of the fuse, contact the manufacturer.)</li> </ul>           If no improvement is made after carrying out the above measures, please contact the manufacturer.         </td> </tr> </table>	Cause	<ul style="list-style-type: none"> <li>• The fuse (4A fuse) installed at the bottom of the 24 V power supply circuit in the controller may have blown out. For the fuse blowout, the emergency stop made by the customer may be the cause, or there may be a ground fault or short circuit with the 24 V power supply in the wiring of a door switch, enabling device, etc.</li> <li>• The T/B might be out of order.</li> </ul>	Measures
Cause	<ul style="list-style-type: none"> <li>• The fuse (4A fuse) installed at the bottom of the 24 V power supply circuit in the controller may have blown out. For the fuse blowout, the emergency stop made by the customer may be the cause, or there may be a ground fault or short circuit with the 24 V power supply in the wiring of a door switch, enabling device, etc.</li> <li>• The T/B might be out of order.</li> </ul>			
Measures	<ul style="list-style-type: none"> <li>• Investigate and correct the ground fault or short circuit portion in the wiring made by the customer. Then, replace the fuse inside the controller. Refer to <a href="#">Page 44, "Fig.2-2 : Fuse (F8) exchange place"</a> for details. (On details of the fuse, contact the manufacturer.)</li> </ul> If no improvement is made after carrying out the above measures, please contact the manufacturer.			







Authorised representative:

MITSUBISHI ELECTRIC EUROPE B.V. GERMANY

Gothaer Str. 8, 40880 Ratingen / P.O. Box 1548, 40835 Ratingen, Germany